

**Ambient NH₃ monitor
APNA-370**

Instruction Manual

CODE:GZ0000080601

Preface

This manual describes the operation of the Ambient NH₃ monitor, APNA-370.

Be sure to read this manual before using the product to ensure proper and safe operation of the instrument. Also safely store the manual so it is readily available whenever necessary.

Product specifications and appearance, as well as the contents of this manual are subject to change without notice.

■ Warranty and Responsibility

HORIBA warrants that the Product shall be free from defects in material and workmanship and agrees to repair or replace free of charge, at HORIBA's option, any malfunctioned or damaged Product attributable to HORIBA's responsibility for a period of one (1) year from the delivery unless otherwise agreed with a written agreement. In any one of the following cases, none of the warranties set forth herein shall be extended;

- Any malfunction or damage attributable to improper operation
- Any malfunction attributable to repair or modification by any person not authorized by HORIBA
- Any malfunction or damage attributable to the use in an environment not specified in this manual
- Any malfunction or damage attributable to violation of the instructions in this manual or operations in the manner not specified in this manual
- Any malfunction or damage attributable to any cause or causes beyond the reasonable control of HORIBA such as natural disasters
- Any deterioration in appearance attributable to corrosion, rust, and so on
- Replacement of consumables

HORIBA SHALL NOT BE LIABLE FOR ANY DAMAGES RESULTING FROM ANY MALFUNCTIONS OF THE PRODUCT, ANY ERASURE OF DATA, OR ANY OTHER USES OF THE PRODUCT.

■ Trademarks

Generally, company names and brand names are either registered trademarks or trademarks of the respective companies.

Conformable Directive

This equipment conforms to the following directives and standards:



Directives: the EMC Directive 89/336/EEC, in accordance with the Article 10 (1) of the Directive
the Low Voltage Directive 73/23/EEC

Standards: [the EMC Directive]
EN61326:1997+A1:1998+A2:2001+A3:2003, Class B, Industry
[the Low Voltage Directive] EN61010-1: 2001

● Installation Environment

This product is designed for the following environment.

- Installation Categories II
- Pollution degree 2

● Information on Disposal of Electrical and Electronic Equipment



The crossed out wheeled bin symbol shown on the product or accompanying documents indicates separate collection for waste electrical and electronic equipment (WEEE) under the WEEE Directive 2002/96/EC in the European Union.

This product should not be disposed of as unsorted household waste.



Your correct disposal of WEEE will contribute to reducing wasteful consumption of natural resources and protecting human health and the environment from potential negative effects caused by hazardous substances in products.

Contact your supplier for information on applicable disposal methods.

FCC Rules

Any changes or modifications not expressly approved by the party responsible for compliance shall void the user's authority to operate the equipment.

■ Note

This equipment has been tested and found to comply with the limits for a Class B digital device, pursuant to part 15 of the FCC Rules. These limits are designed to provide reasonable protection against harmful interference in a residential installation. This equipment generates, uses, and can radiate radio frequency energy and, if not installed and used in accordance with the instructions, may cause harmful interference to radio communications. However, there is no guarantee that interference will not occur in a particular installation. If this equipment does cause harmful interference to radio or television reception, which can be determined by turning the equipment off and on, the user is encouraged to try to correct the interference by one or more of the following measures:

- Reorient or relocate the receiving antenna.
- Increase the separation between the equipment and receiver.
- Connect the equipment into an outlet on a circuit different from that to which the receiver is connected.
- Consult the dealer or an experienced radio/TV technician for help.

Safety Policy

■ Warnings and Warning Labels

We arrange warning labels on our products, and describe notes and cautions in this manual. Make sure to follow these instructions for your safety.

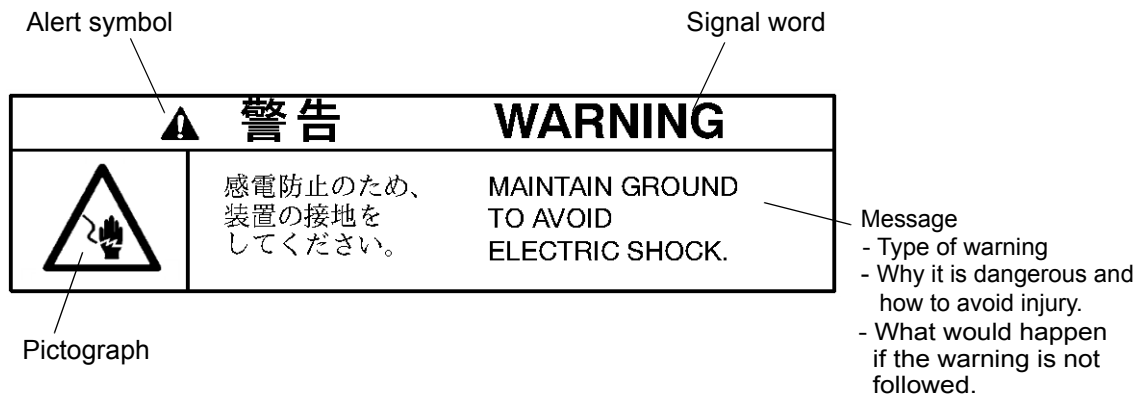

● The meanings of the signal words are as follows

- **WARNING:**
This indicates a potentially hazardous situation which, if not avoided, could result in death or serious injury.
- **CAUTION:**
This indicates a potentially hazardous situation which, if not avoided, may result in minor or moderate injury. It may also be used to alert against unsafe practices.

■ Labels and Location

● Label location

Top

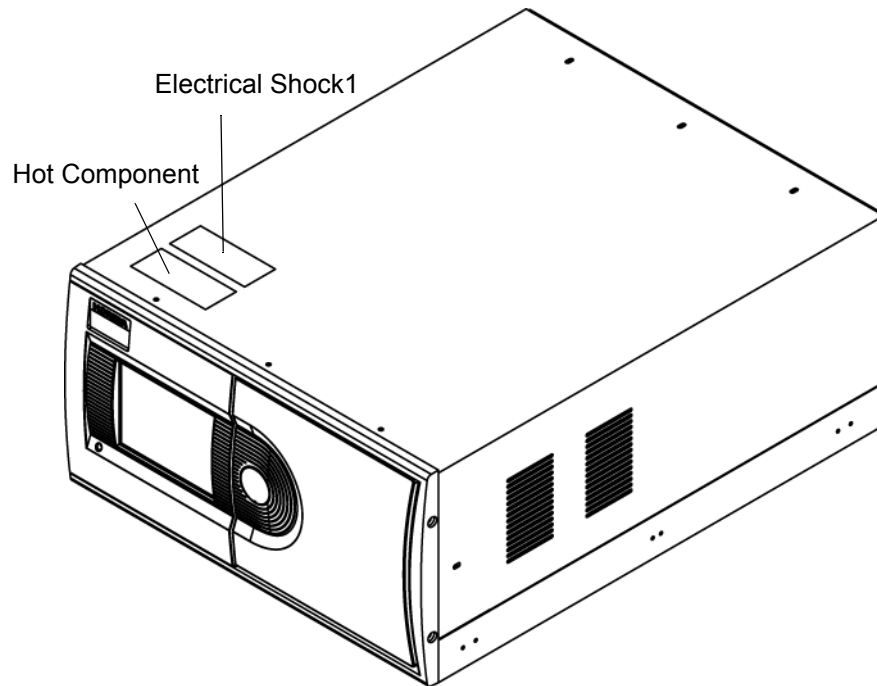

Rear

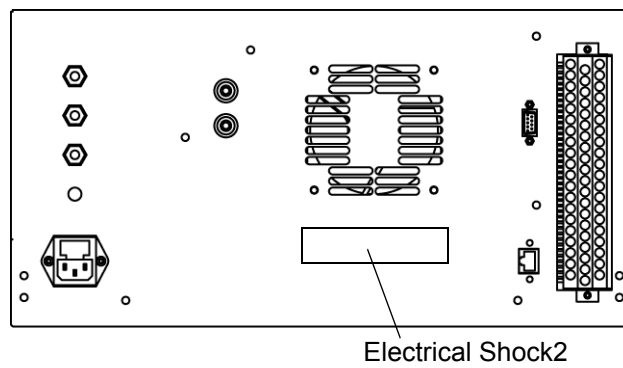

● Labels

Hot Component



Electrical Shock1

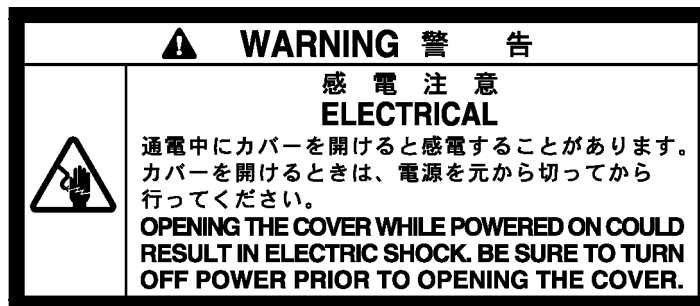

Electrical Shock2

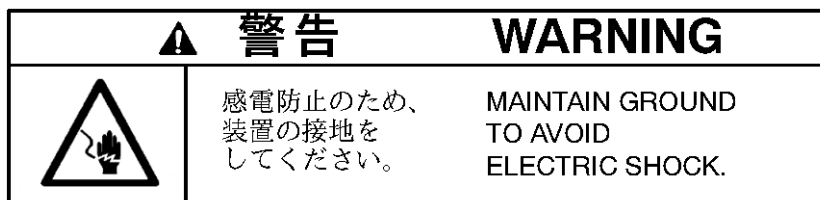

■ Description in this manual

Notes and cautions are described in the following styles:

Note

APNA-370 uses a touch screen. Directly press keys displayed on that screen with your finger. When pressing these keys, do not use a ballpoint pen or any other tool with a hard or sharp end. This might cause a malfunction.

And tips are described in the following style:

Tip

Two different calibration gas concentrations can be set for the [SPAN] and [MEAS.] lines.

Contents

1	OVERVIEW	1
1.1	Introduction	1
1.2	System Configuration	1
1.3	Part Names	2
1.3.1	Front panel	2
1.3.2	Rear panel	3
2	BASIC OPERATIONS	4
2.1	Start-up (Measurement Start)	4
2.2	Shutdown	5
2.3	Basic Operation Flow	6
3	MEAS. SCREEN (BASIC SCREEN)	7
4	CALIBRATION	11
4.1	Calibration-related Screens	12
4.1.1	CAL. screen	12
4.1.2	MODE screen	13
4.1.3	Screens for value setting	14
4.2	Preparation for Calibration	15
4.2.1	Entering the span gas concentration value	15
4.3	Automatic Calibration (AIC)	17
4.3.1	AIC setting	17
4.3.2	Precautions in setting the AIC sequence	22
4.3.3	Setting the AIC sequence	23
4.3.4	Starting the AIC sequence with the [AIC] key	26
4.4	Manual Calibration	27
4.4.1	Operational flow	27
4.4.2	Zero calibration	28
4.4.3	Span calibration	29
4.4.4	Finishing calibration	30
5	DATA PROCESSING	31
5.1	Average	34
5.2	Integration	36
5.3	Rolling Average	38

6	FUNCTIONALITIES	39
6.1	Data Menu	40
6.2	History Menu	40
6.2.1	Calibration history	42
6.2.2	Alarm history	42
6.3	Maintenance Menu	43
6.3.1	Analog output	43
6.3.2	Analog input	48
6.3.3	Maintenance status	49
6.4	Range Menu	50
6.4.1	ANALOG OUTPUT 1 range (momentary value)	52
6.4.2	ANALOG OUTPUT 2 range (rolling average)	52
6.5	Setting Menu	53
6.5.1	Time adjustment	54
6.5.2	Unit conversion factor	55
6.5.3	Integration reset setting	57
6.5.4	AIC setting	57
6.5.5	AIC sequence setting	57
6.6	System Menu	58
6.6.1	LCD setting	58
6.6.2	Touch panel adjustment	60
6.6.3	Password setting	61
6.6.4	Turning ON/OFF the ozone lamp	63
6.6.5	Data saving	64
6.7	Key Lock	65
7	DAILY CHECKS	67
7.1	Before Maintenance	67
7.2	Replacing the Filter Element	68
7.3	List of Consumables and Replacement Parts	68
8	TROUBLESHOOTING	69
8.1	Alarm Check	69
8.2	Alarm List	71
8.3	Troubleshooting	74
9	EXTERNAL INPUT/OUTPUT	76
9.1	Terminal Block Specifications	76



9.1.1	Range output for analog output	76
9.1.2	Contact input	76
9.1.3	Contact output	77
9.1.4	Alarm output	77
9.1.5	Analog output	77
9.1.6	Power shutoff output	77

10	APPENDIX	78
10.1	Measurement Principle	78
10.2	Dryer Unit	78
10.3	Specification	79
10.4	Unpacking	80
10.5	Installation	80
10.5.1	Installation environment	80
10.5.2	Installation place	80

1 OVERVIEW

1.1 Introduction

The APNA-370 has been designed for measuring the concentration of NH_3 in ambient air based on the chemiluminescence method (CLD method).

This instrument measures NO_x and NH_3 continuously.

For analog output of NO_x and NH_3 , you may select from any two of these three: the momentary value, the integration value, and the average value.

The APNA-370's RS-232C (option) port allows data communication and remote control.

1.2 System Configuration

APNA-370 is a standalone system that allows you to operate it by merely connecting a calibration gas diluter.

The system can be upgraded by connecting a computer, monitor, recorder, calibration gas generator.

The system configuration of APNA-370 is shown in the following diagram:

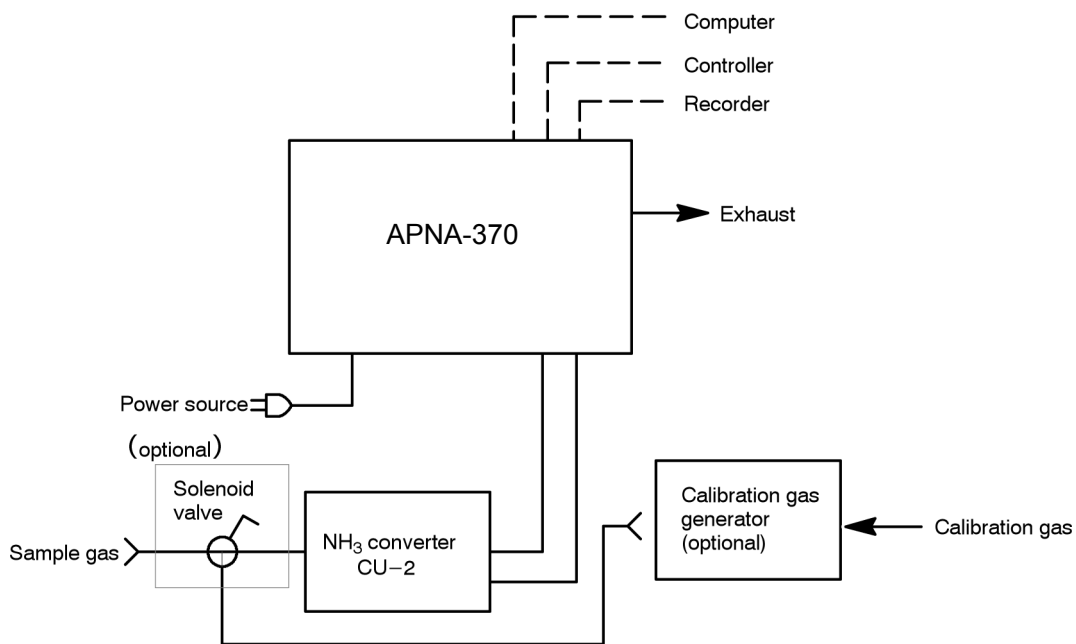

Fig. 1 System configuration

1.3 Part Names

1.3.1 Front panel

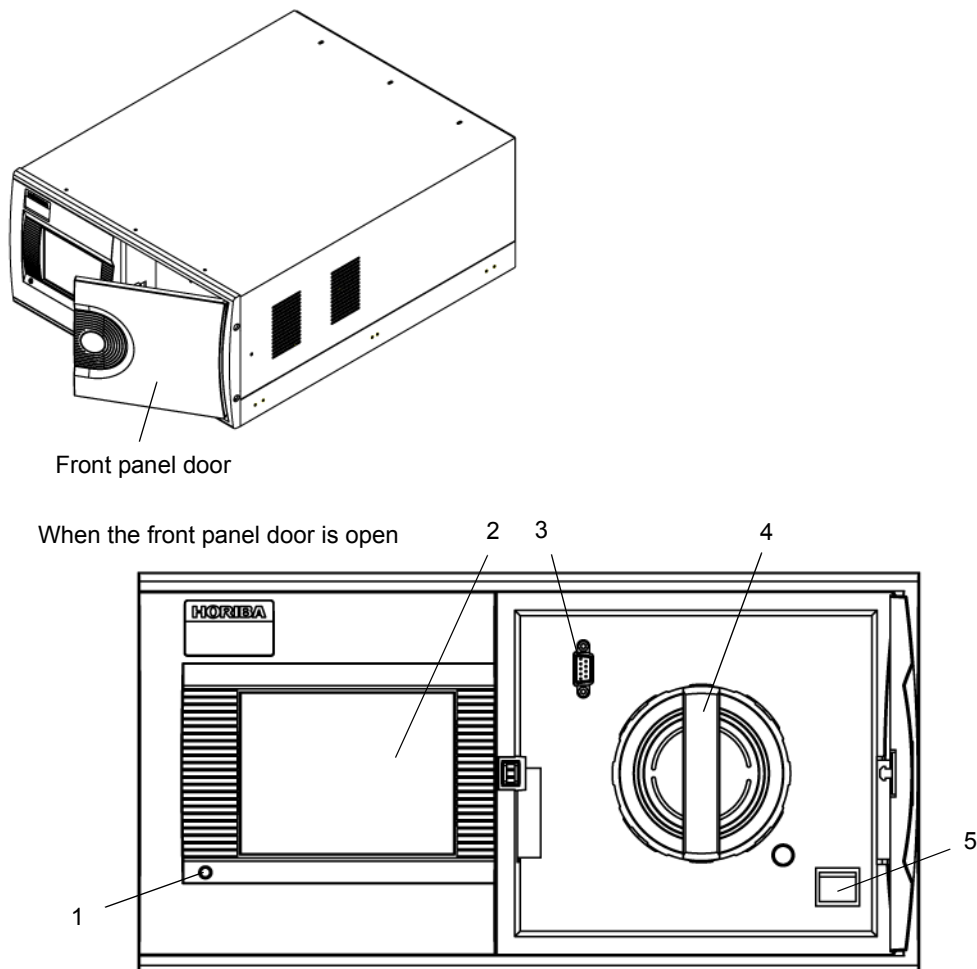

Fig. 2 Front panel

Name	Description
1 Power ON LED	When APNA-370 is ON, this LED is illuminated as follows: Green: During normal operation Red: In alarm conditions
2 Touch panel	Displays the measured values, alarms, etc. and touch-keys for operation.
3 RS-232C output port	Used for maintenance and adjustments.
4 Sample filter	A filter for the sample line. Replace this filter about every 2 weeks. (See page 68. The actual replacement frequency depends on the sample gas conditions.)
5 Power switch	Used to turn ON/OFF the main power supply.

1.3.2 Rear panel

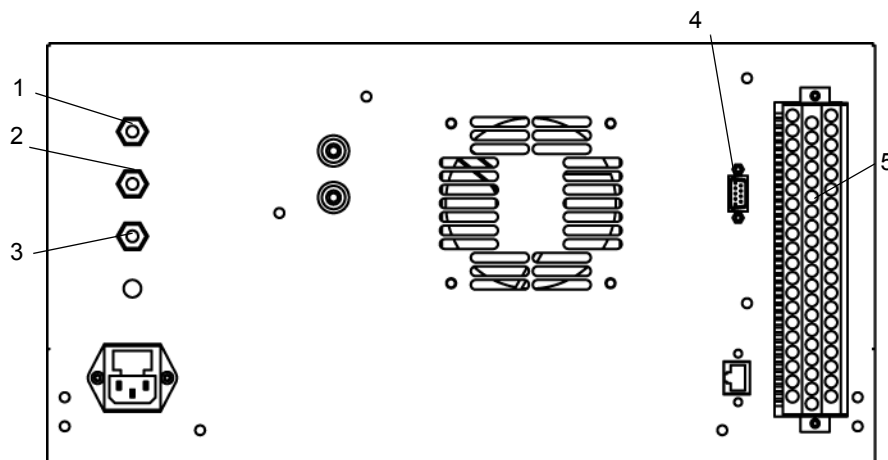

Fig. 3 Rear panel

Name	Description
1 Reference gas inlet	The reference gas inlet with a connector for a Teflon tube of 6 mm O.D./ 4 mm I.D.
2 Sample inlet	The sample gas inlet with a connector for a Teflon tube of 6 mm O.D./ 4 mm I.D.
3 Exhaust outlet	The measured gas outlet with a connector for a Teflon tube of 6 mm O.D./ 4 mm I.D. Release the measured gas to a safe location where the back pressure stays stable within a range of ± 980 Pa.
4 RS-232C (optional)	
5 Signal connection terminal block	For the signals, see "9 EXTERNAL INPUT/OUTPUT" (page 77).

Note

The measured gas is released from the exhaust outlet at a rate of 1.1 L/min.
The NO gas used for calibration is toxic. Be sure to connect an exhaust tube.

2 BASIC OPERATIONS

2.1 Start-up (Measurement Start)

1. Power ON

Press the power switch located on the front panel to turn ON the main power supply. The MEAS. screen is automatically displayed. If the conditions of flow rate and converter temperature meet the regulation, the measurement starts.

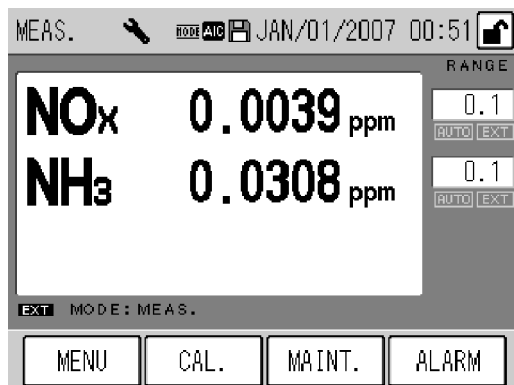

Fig. 4 Initial screen

2. Warm-up

Wait for Warm up time (about 3 hours).

Note

- The [ALARM] key may be illuminated* during warm-up, but this does not affect the warm-up process.
If the [ALARM] key is still illuminated 3 hours later, see “8.2 Alarm List” (page 71) to take action. Since the end of warm-up is not displayed, it is recommended to warm up at night or in any other time zone when the operation is not affected.
* [ALARM] key illumination: The CONV (converter temperature) alarm is outputted for about 1 hour after the power is turned ON.
- In order to obtain stable, accurate data, perform calibration at the measurement start and regular intervals (see “4 CALIBRATION” (page 11)).
- Keep turning ON the O₃ generator during measurement.
Making the key lock function ON prevents wrong operation (“6.7 Key Lock” (page 65)).
- If any of converter alarm, flow rate alarm, pressure alarm occurs, the O₃ generator becomes OFF, regardless of whether the O₃ generator is powered ON or OFF.

2.2 Shutdown

Keep APNA-370 powered ON for a while after the O₃ lamp is turned OFF. And the ozone inside the system will be replaced with atmospheric air.

To prevent ozone from remaining in the piping and decaying the system, follow the procedures mentioned below to shut down the system.

Note

- The average and integration values are saved in the flash memory every 10 minutes. Before turning OFF the power, be sure to save the data in the memory (see “6.6.5 Data saving” (page 64)).
- If power outage or a similar accident occurs, data may not be recorded for 10 minutes at a maximum.

-
1. Save the data in the memory (see “6.6.5 Data saving” (page 64)).
 2. Power OFF the O₃ generator (see “6.6.4 Turning ON/OFF the ozone lamp” (page 63)).
 3. Wait approximately 10 minutes, and then turn OFF the power of APNA-370.
Before a long-term shutdown, it is recommended to replace the filter element (see “7.2 Replacing the Filter Element” (page 68)).

2.3 Basic Operation Flow

To perform operations, ensure that the installation, wiring, and piping connections have been completed.

(Connect the external input/output as necessary.)

● **For the first use**

Power ON	Turn ON the power.	2.1 Start-up (Measurement Start) (page 4)
↓		
Setting	Unlock the keys*1	6.7 Key Lock (page 65)
	Set the current time.	6.5.1 Time adjustment (page 54)
	Set the start time, interval for calibration mode or operation using the internal clock.	4.3.1 AIC setting (page 17)
	Set the calibration sequence (zero span time)	4.3.3 Setting the AIC sequence (page 23)
↓		
Output setting	Set the analog output range (Fixed, Auto, or External). The default setting is "Auto." Select a desired mode in accordance with your use.	6.4 Range Menu (page 50)
↓		
Password change	The default value is 1234. Change this value as necessary.	6.6.3 Password setting (page 61)
↓		
Span gas connection	Connect the span gas line to be used and then check this connection.	
↓		
Span gas concentration entry	Enter the concentration of the span gas to be used.	4.2.1 Entering the span gas concentration value (page 15)
↓		
Calibration	Perform calibration automatically or manually.	4.3 Automatic Calibration (AIC) (page 17) 4.4 Manual Calibration (page 27)
↓		
Measurement	Perform the continuous measurement.	

*1: The default password is 1234.

3 MEAS. SCREEN (BASIC SCREEN)

Note

APNA-370 uses a touch screen. Directly press keys displayed on that screen with your finger. When pressing these keys, do not use a ballpoint pen or any other tool with a hard or sharp end. This might cause a malfunction.

This chapter describes the MEAS. screen that is displayed immediately after the power is turned ON.

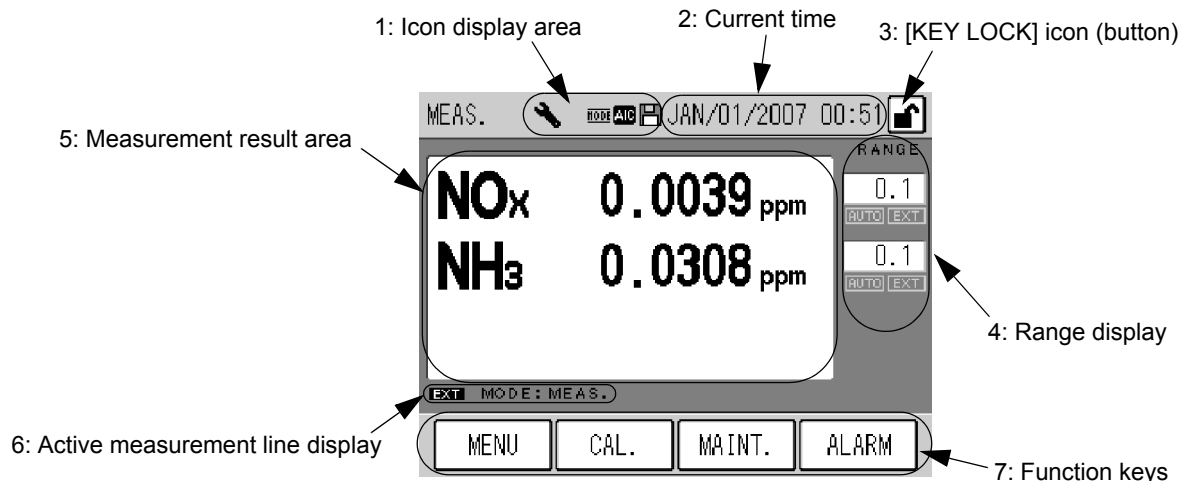

Fig. 5 MEAS. screen

1: Icon display area

The icons showing the state of the instrument are displayed in this area.

Maintenance mode: This icon blinks when the maintenance switch is turned ON.

For the maintenance switch, see "7.1 Before Maintenance" (page 67).



The maintenance switch is ON manually



The maintenance switch is ON under external control

Fig. 6 Maintenance mode icon

Note

In the case of the standard specifications, the MNT (Maintenance) signal is outputted when the maintenance switch is ON.

Ozone: This icon is illuminated when the ozone lamp is ON ("6.6.4 Turning ON/OFF the ozone lamp" (page 63)).



Fig. 7 Ozone icon

Line: This icon is illuminated when gas is being sucked through any line other than the MEAS. line.
When the gas line is switched to the MEAS. line, this icon remains illuminated during the MEASURE time specified in the AIC sequence.



Fig. 8 Line icon

AIC mode: This icon blinks when the AIC sequence is in progress.



Fig. 9 AIC mode icon

Saving: This icon is illuminated when data is being written to the flash memory.
Data is saved when any setting is modified or every 10 minutes during data acquisition.



Fig. 10 Saving icon

Note

When the Saving icon is displayed, do not turn OFF the power. If you do that, the data will not saved.

2: Current time

The current time is displayed.

For setting the current time, see “6.5.1 Time adjustment” (page 54).

3: [KEY LOCK] icon (button)

The key locked/unlocked mode is displayed.

When this icon is displayed in a box, it works as the operation button of key lock/unlock.

In this state, pressing this button displays the KEY LOCK screen (Fig. 82 on page 65) allowing you to lock/unlock the keys.



Keys are locked



Keys are unlocked

Fig. 11 [KEY LOCK] icon (button)

When the keys are locked, you cannot operate with the screen; you can only view the screen. This prevents any wrong operation from causing a modification in the settings.

4: Range display

The current range and range mode are displayed.

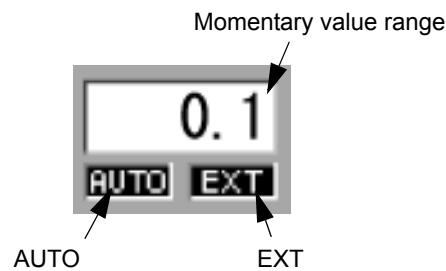

Fig. 12 Range display

Momentary value range:	The current momentary value range is displayed.
AUTO:	Displayed when the automatic range function is used.
EXT:	Displayed when the external input for range switching is used.

Note

- For range setting, see “6.4 Range Menu” (page 50).
- The external input of range switching can be controlled via contact input (optional) or the RS-232C port (optional).

5: Measurement result area

Measurement results are displayed.

6: Active measurement line display

The currently selected measurement line is displayed.

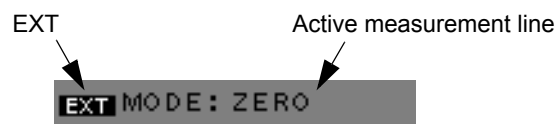

Fig. 13 Active measurement line display

EXT:	Displayed when the external input for line switching is used.
Active measurement line:	The currently selected measurement line is displayed. <ul style="list-style-type: none"> • ZERO: The zero gas line is now being selected. • SPAN: The span gas line is now being selected. • MEAS.: The measured line is now being selected.

Note

- For the external input of line switching, see “4.1.2 MODE screen” (page 13).
- The external input of line switching can be controlled via contact input (optional) or the RS-232C port (optional).

7: Function keys

The keys allow you to perform the following operations.

- | | |
|-----------|-----------------------------------------------------------------------------------------------------------------------------------------------------------------------------------------------------|
| [MENU]: | The MENU screen (Fig. 47 on page 39) is displayed. |
| [CAL.]: | The CAL. screen (Fig. 14 on page 12) is displayed. |
| [MAINT.]: | The MAINTENANCE screen for operating the maintenance switch (Fig. 84 on page 67) is displayed. |
| [ALARM]: | Displayed when an error occurs in the instrument.
Pressing the displayed [ALARM] key will allow you to view the current alarms.
For the details of alarms, see “8 TROUBLESHOOTING” (page 69). |

4 CALIBRATION

In order to acquire stable, accurate data, perform calibration when starting measurement and at regular intervals.

There are two types of calibration, the auto calibration (AIC) and the manual calibration.

Auto calibration (AIC)

The AIC sequence is executed at the specified time intervals or with the externally inputted command to perform the zero calibration and span calibration automatically.

Manual calibration

This calibration is performed manually at an arbitrary timing.

There are two methods available for the manual calibration; one uses the calibration gas line, and the other supplies the calibration gas to the measured gas line.

4.1 Calibration-related Screens

This section describes the screens used for the automatic calibration and manual calibration.

4.1.1 CAL. screen

This is the basic screen for calibration.

To display the CAL. screen, press the [CAL.] key on the MEAS. screen (Fig. 5 on page 7).

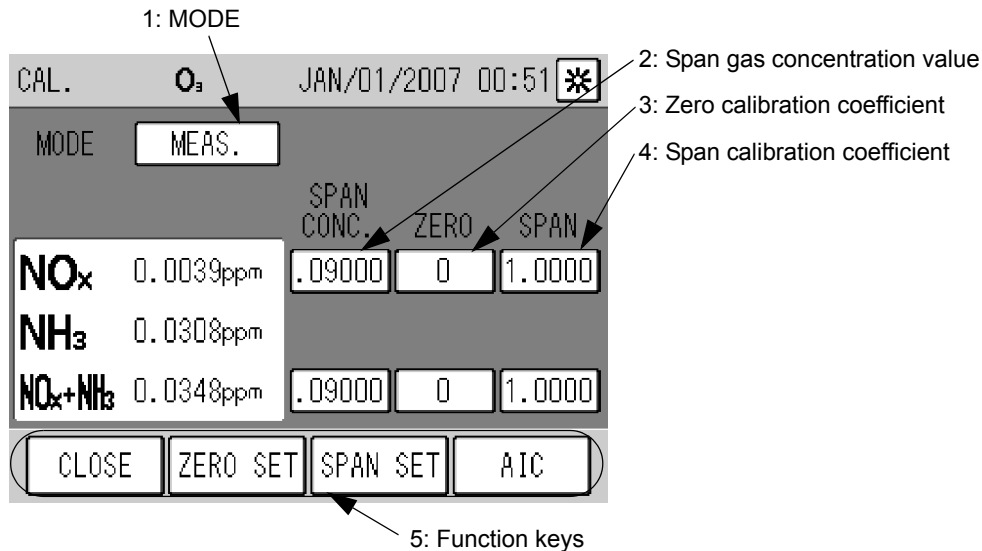

Fig. 14 CAL. screen

1: MODE

The selected measurement line is displayed.

Press the displayed MODE setting, and the MODE screen will be displayed (see “4.1.2 MODE screen” (page 13)).

2: Span gas concentration value

The entered span gas concentration value is displayed.

Different values can be entered for the measured gas and span gas lines.

Press the displayed span gas concentration value, the SPAN CONC. screen will be displayed (see “4.1.3 Screens for value setting” (page 14)).

Note

No span gas concentration value can be entered when the ZERO line is set for MODE.

3: Zero calibration coefficient

The entered zero calibration coefficient is displayed.

Press the displayed zero calibration coefficient, the ZERO ADJUST screen will be displayed (see “4.1.3 Screens for value setting” (page 14)).

4: Span calibration coefficient

The entered span calibration coefficient is displayed.

Press the displayed span calibration coefficient, the SPAN ADJUST screen will be displayed (see “4.1.3 Screens for value setting” (page 14)).

5: Function keys

The keys allow you to perform the following operations.

- [CLOSE]: Returns to the MEAS. screen (Fig. 5 on page 7).
- [ZERO SET]: Displays the zero calibration message (Fig. 36 on page 28).
- [SPAN SET]: Displays the span calibration message (Fig. 38 on page 29).
- [AIC]: Displays the AIC start message (Fig. 33 on page 26).
Pressing this key during the execution of AIC (the AIC mode icon blinks) displays the AIC abort message (Fig. 34 on page 26).

4.1.2 MODE screen

The measurement line can be switched on this screen.

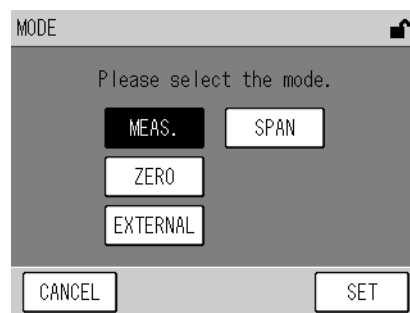

Fig. 15 MODE screen

Press the button for the item to be set.

- MEAS.: To use the MEAS. line, select this button.
- SPAN: To use the SPAN line, select this button.
- ZERO: To use the ZERO line, select this button.
- EXTERNAL: To use the external contact (optional) for line switching, select this button.

The keys allow you to perform the following operations.

- [CANCEL]: Returns to the CAL. screen without changing the settings.
- [SET]: Returns to the CAL. screen with the settings changed.

4.1.3 Screens for value setting

Pressing each display of span gas concentration value, zero calibration coefficient, or span calibration coefficient will display a screen including the numeric keypad that allows you to enter the respective values.

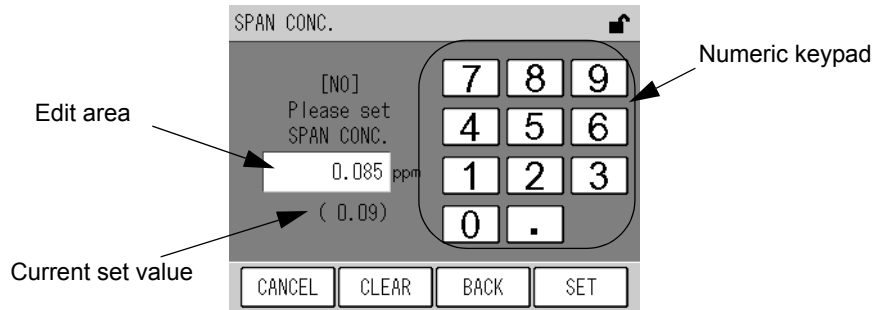

Fig. 16 A screen for value setting (SPAN CONC.)

Item	Settable range	Default setting
Span gas concentration value	.00001 to 99999.	---
Zero calibration coefficient	-3500 to 3500	0
Span calibration coefficient	.50000 to 2.0000	1.0000

Enter a value via the numeric keypad.

The keys allow you to perform the following operations.

- [CANCEL]: Returns to the CAL. screen without changing the settings.
- [CLEAR]: Deletes the value entered in the edit area
- [BACK]: Deletes the just entered figure (1-digit).
- [SET]: Returns to the CAL. screen with the settings changed.

Note

If you enter any value that does not meet the settable range, it will be automatically corrected to the nearest value in the settable range.

4.2 Preparation for Calibration

4.2.1 Entering the span gas concentration value

Enter the span gas concentration value to be used for the calibration.

1. Press the displayed **MODE** setting on the **CAL.** screen. The **MODE** screen will be displayed.

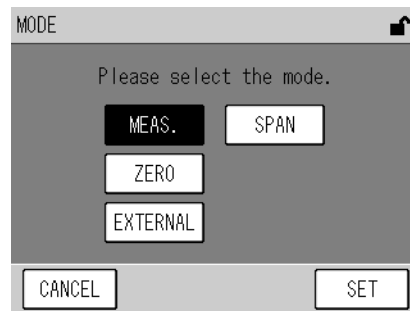

Fig. 17 MODE screen

2. Select the measurement line corresponding to the line to be used for the calibration.
 - For manual calibration using the calibration gas line: [SPAN]
 - For manual calibration using the measured gas line: [MEAS.]
 - For auto calibration (AIC): [SPAN]

Tip

Two different calibration gas concentrations can be set for the [SPAN] and [MEAS.] lines.

3. Press the [SET] key to return to the **CAL.** screen.

4. Press the displayed Span Conc. value. The SPAN CONC. screen will be displayed.

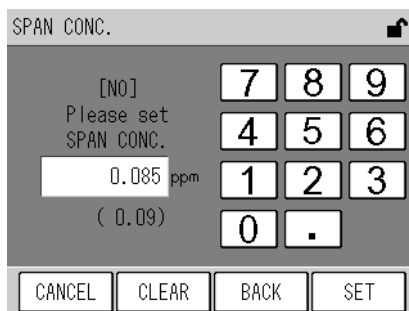

Fig. 18 SPAN CONC. screen

item	Settable range
Span Conc. value	.00001 to 99999.

Enter a value via the numeric keypad.

The keys allow you to perform the following operations.

- [CANCEL]: Returns to the CAL. screen without changing the settings.
- [CLEAR]: Deletes the value entered in the edit area
- [BACK]: Deletes the just entered figure (1-digit).
- [SET]: Returns to the CAL. screen with the settings changed.

5. Enter a span gas concentration via the numeric keypad.
6. Press the [SET] key to return to the CAL. screen.

4.3 Automatic Calibration (AIC)

Automatic calibration (AIC) is started and performed with the internal clock, according to the AIC sequence and conditions set in advance. The AIC sequence can also be started arbitrarily by pressing the [AIC] key on the CAL screen.

4.3.1 AIC setting

1. Press the [MENU] key on the MEAS. screen.
2. Press either the [◀] or [▶] key to display the MENU/SETTING screen.

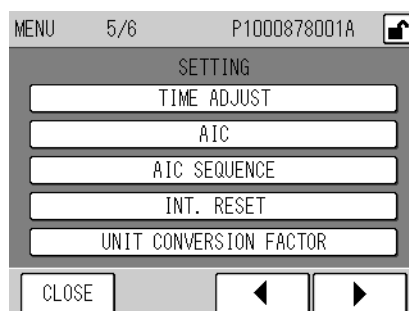

Fig. 19 MENU/SETTING screen

3. Press the [AIC] button. The AIC screen will be displayed.

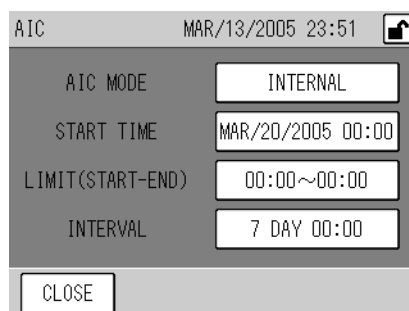

Fig. 20 AIC screen

Item	Description
AIC MODE	Used to specify the method of AIC start. Pressing the displayed AIC MODE setting will display the AIC MODE screen (Fig. 21 on page 18).
START TIME	Used to set the time for starting the next AIC sequence. When the internal clock reaches or exceeds the specified time, the AIC sequence will start. Pressing the displayed START TIME setting will display the START TIME screen (Fig. 22 on page 19).
LIMIT (START-END)	Used to set the range of time available for starting the AIC sequence. Pressing the displayed LIMIT (START-END) setting will display the LIMIT (START-END) screen (Fig. 23 on page 20).
INTERVAL	Used to set the time interval, which applies if the AIC sequence is started periodically. Pressing the displayed INTERVAL setting will display the INTERVAL screen (Fig. 24 on page 21).

Note

Only when AIC MODE is set to INTERNAL, the items of START TIME, LIMIT (START-END), and INTERVAL are displayed. These items are not displayed when AIC MODE is set to NONE or EXTERNAL.

4. Press the displayed item to be set. The corresponding setting screen will be displayed.

For the detailed explanation of each screen, see page 18 to page 22.

5. On the setting screen, change the settings and then press the [SET] key. The changed settings will be saved, and the AIC screen will be displayed again.

Tip

To cancel the changes, press the [CANCEL] key. The changes will be undone, and the AIC screen will be displayed again.

6. Press the [CLOSE] button on the AIC screen to return to the MENU screen.

● **AIC MODE**

Specify the method of starting the AIC.

Press the displayed AIC MODE setting on the AIC screen. The AIC MODE screen will be displayed.

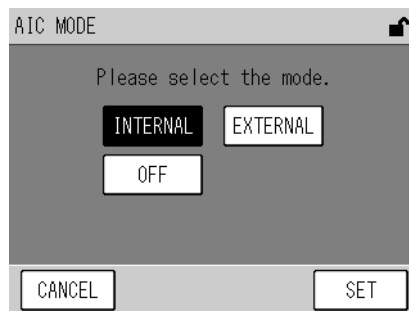

Fig. 21 AIC MODE screen

Item	Description
INTERNAL	Selects the mode of using the internal clock to execute AIC at the specified start time and intervals with .
EXTERNAL	Selects the mode of using the external start signal (external contact input) to start AIC. For the telemeter connection specifications, if the telemeter input contact is open (telemeter malfunction), AIC will be started using the internal clock.
OFF	Selects the mode without AIC automatic start.

Press the button of the item to be set.

Note

- Manual AIC start and the start via the RS-232C port are valid regardless of this setting.
- If an AIC start signal is inputted externally while an AIC sequence is in progress, this signal will be disregarded and the ongoing AIC sequence will be continued.

Tip

For the telemeter connection specifications, to execute AIC using the internally set START TIME and INTERVAL automatically even if the start signal is not inputted because of telemeter malfunction, set AIC MODE to EXTERNAL.

● START TIME

Set the time for starting the next AIC sequence.

Pressing the displayed START TIME setting will display the START TIME screen.

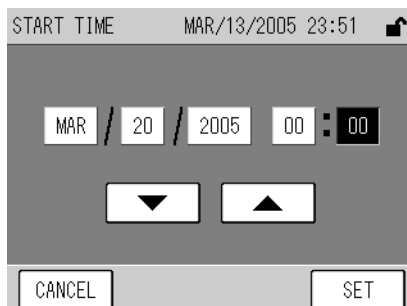

Fig. 22 START TIME screen

Item	Settable range
Year	2000 to 2099
Month	01 to 12
Day	01 to 31
Hour	00 to 23
Minute	00 to 59

Press the value to be changed. The value will be highlighted, allowing you to change it. Using the [▼] and [▲] buttons, change the value.

Note

- The START TIME setting is based on the internal clock.
- The practical range of Year setting is 2000 to 2089.
- The START TIME can not be set to any date that does not practically exist.
If the [SET] key is pressed with such a value entered, the nearest date and time will be set automatically.
- The START TIME can not be set to any time outside the current LIMIT (START-END) setting.
If the [SET] key is pressed with such a value entered, the setting is changed automatically so as to be within the range.
- Once the AIC sequence starts, the START TIME setting will be changed to the expected START TIME of the next AIC (the current START TIME + INTERVAL). If the calculated time does not meet the settable ranges of the LIMIT (START-END), it will be corrected automatically. (See page 22.)
- If the START TIME is set to any time earlier than the current time, the setting will be changed to the minimum later than the current time, which is obtained by adding an integral multiple of the INTERVAL setting to the current START TIME. If the calculated time does not meet the settable ranges of the LIMIT (START-END), it will be corrected automatically.
- If the START TIME becomes earlier than the current time by adjusting the internal clock (see "6.5.1 Time adjustment" (page 54)), the setting will be changed to the minimum later than the current time, which is obtained by adding an integral multiple of the INTERVAL setting to the current START TIME. If the calculated time does not meet the settable ranges of the LIMIT (START-END), it will be corrected automatically.

● LIMIT (START-END)

Set the range of time available for starting the AIC sequence.

Pressing the displayed LIMIT (START-END) setting will display the LIMIT (START-END) screen.

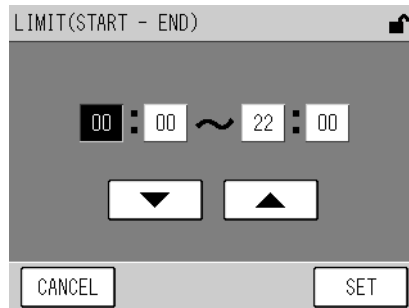

Fig. 23 LIMIT (START-END) screen

Item	Settable range
Start: Hour	00 to 23
Start: Minute	00 to 59
End: Hour	00 to 23
End: Minute	00 to 59

Press the value to be changed. The value will be highlighted, allowing you to change it. Using the [▼] and [▲] buttons, change the value.

Note

- When you do not use the LIMIT (START-END) function, select the default value (00:00 to 00:00).
 - If the START and END values of the range are the same, the LIMIT (START-END) function is invalid.
-

● **INTERVAL**

Set the time interval, which applies if the AIC sequence is started periodically. Pressing the displayed INTERVAL setting will display the INTERVAL screen.

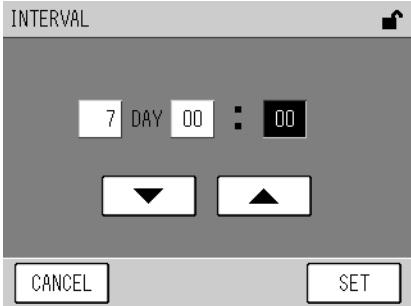

Fig. 24 INTERVAL screen

Item	Settable range
Day	0 to 999
Hour	00 to 23
Minute	00 to 59

Press the value to be changed. The value will be highlighted, allowing you to change it. Using the [▼] and [▲] buttons, change the value.

Note

INTERVAL should be set to the AIC sequence time plus 10 minutes or longer. If the [SET] key is pressed with a shorter interval entered, the period equivalent to the AIC sequence time plus 10 minutes will be set automatically.

4.3.2 Precautions in setting the AIC sequence

● **Automatic correction of start time**

When AIC MODE is set to INTERNAL and an AIC sequence is started, the expected START TIME of the next AIC is calculated using the following equation:

$$\text{Expected START TIME of the next AIC (calculated value)} = \text{the current START TIME} + \text{INTERVAL}$$

If the calculated time is within the settable range of START TIME, the START TIME setting is changed to the calculated time.

If the calculated time is not within the settable range of START TIME, the START TIME setting is changed to the START time or the END time, whichever is farther from the calculated time, of the closest LIMIT (START-END) to the calculated time.

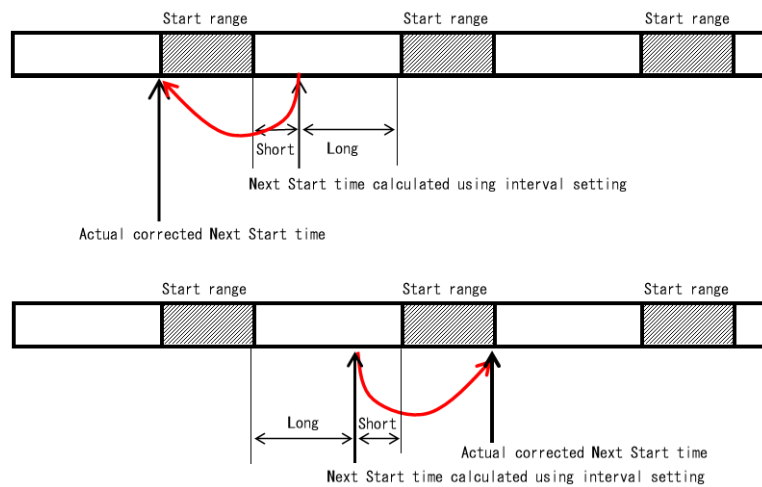

Fig. 25 Automatic correction of START TIME based on the LIMIT (START-END) setting

An example of the automatic correction of start time is given below.
 If the AIC conditions are as follows:

- START TIME: 20:30
- LIMIT (START-END): 5:00 to 23:00
- INTERVAL: 1 day and 1 hour (25 hours)

START TIME is delayed by one hour every day. As days pass, START TIME eventually runs out of the LIMIT (START-END) setting.

In this example, since the calculated value of the fourth START TIME (23:30) is not within the LIMIT (START-END) setting, the fourth START TIME is changed to the START time (5:00) of the LIMIT (START-END) just before the calculated time.

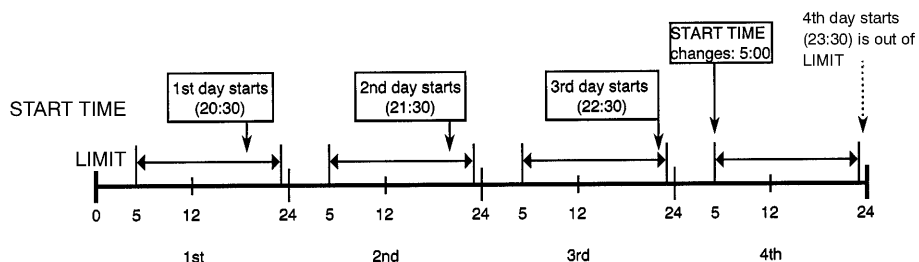

Fig. 26 An example of automatic correction of START TIME

4.3.3 Setting the AIC sequence

To set the AIC sequence, go to the AIC SEQUENCE screen.

1. Press the [MENU] key on the MEAS. screen.
2. Press the [◀] or [▶] key to display the MENU/SETTING screen.

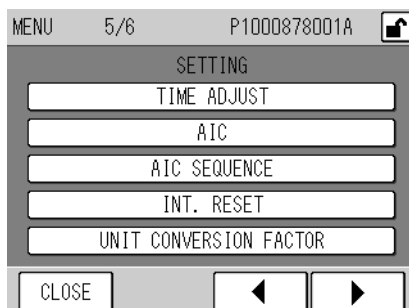

Fig. 27 MENU/SETTING screen

3. Press the [AIC SEQUENCE] button. The AIC SEQUENCE screen will be displayed.

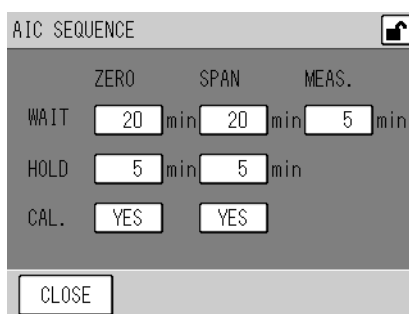

Fig. 28 AIC SEQUENCE screen

Item	Settable range	Description
WAIT	0 min to 999 min	Set the waiting time for stabilization after changing gas. The recommended setting is 20 minutes or longer.
HOLD	0 min to 999 min	Set the calibration validation time (to check the readouts on the recorder after finishing the calibration).
CAL	YES/NO	Specify whether or not to perform calibration. YES: Calibration is performed. NO: Calibration is not performed.

4. Press the displayed setting to be changed. The corresponding setting screen will be displayed.

- WAIT or HOLD:

The following screen for time setting will appear:

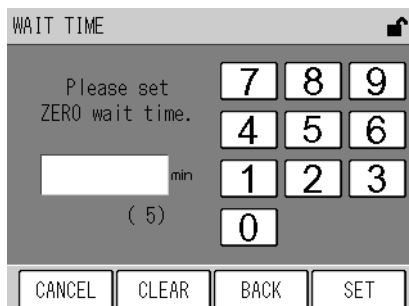

Fig. 29 A screen for time setting (WAIT TIME)

- CAL:

The following CAL. screen for setting will appear.

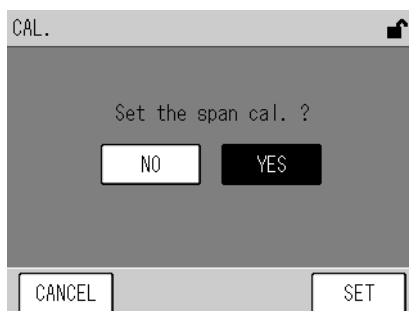

Fig. 30 CAL. screen (for SPAN)

5. Change the setting by entering time on the time setting screen or pressing either [YES] or [NO] button on the CAL. screen, and then press the [SET] key. The setting will be changed and the AIC SEQUENCE screen will be displayed again.

Note

- Any process for which time is set to 0 min is skipped and the AIC sequence proceeds to the next step. For example, if WAIT for SPAN is set to 0 min, no span gas will be supplied.
- If CAL. is set to NO, calibration is not performed in the AIC sequence.
- If the total time of the AIC sequence exceeds the value of AIC INTERVAL minus 10 min, the AIC INTERVAL setting will be automatically changed to the value of the total time of the AIC sequence plus 10 min.

6. Press the [CLOSE] button on the AIC SEQUENCE screen. The MENU screen is displayed again.

An example of the AIC sequence is shown in the following diagram:

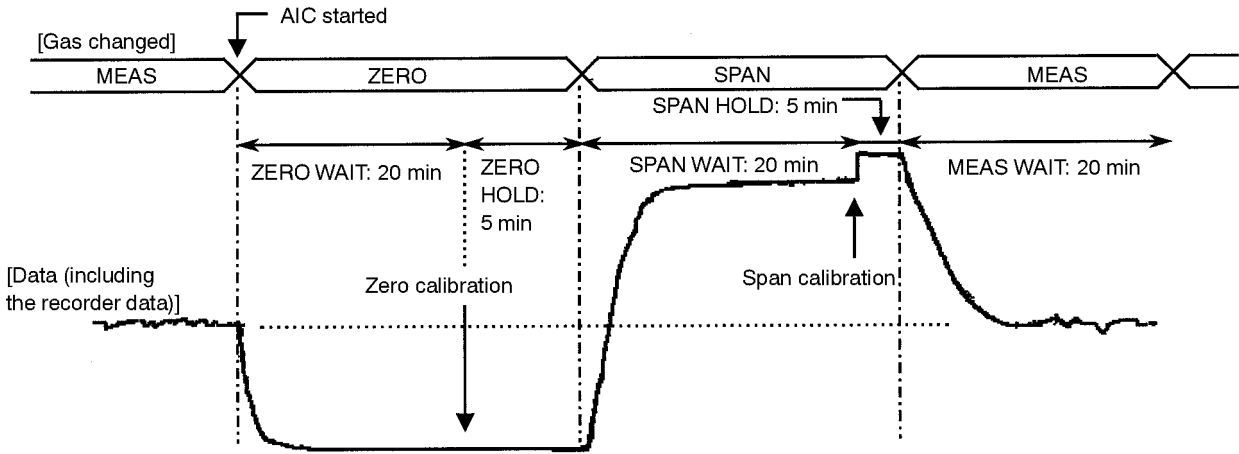

Fig. 31 An example of the AIC sequence

4.3.4 Starting the AIC sequence with the [AIC] key

1. Press the [CAL.] key on the MEAS. screen. The CAL. screen will be displayed.

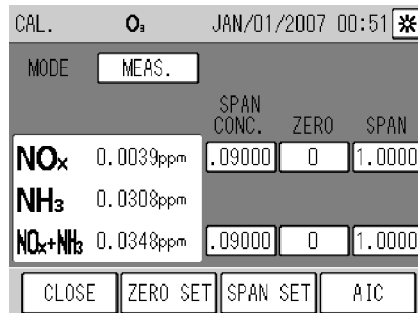

Fig. 32 CAL. screen

2. Press the [AIC] key. The AIC start message will appear.

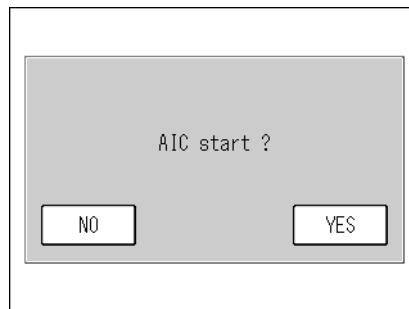

Fig. 33 AIC start message

3. Press the [YES] button. The preset AIC sequence will start.

While the AIC sequence is in progress, the CAL. screen is displayed again and the AIC mode icon blinks. Pressing the [AIC] key in this state displays the AIC abort message.

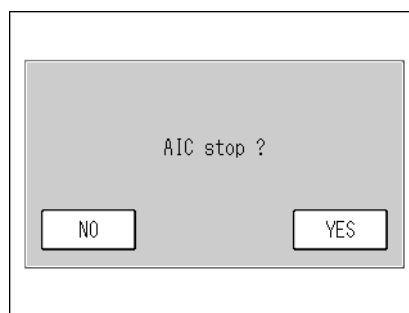

Fig. 34 AIC abort message

The keys allow you to perform the following operations.

- [YES]: The ongoing AIC sequence will be aborted.
 [NO]: The ongoing AIC sequence will be continued.

Note

For the AIC sequence and its setting, see page 17 to page 25.

4.4 Manual Calibration

After preparing for the calibration (see “4.2 Preparation for Calibration” (page 15)), perform the zero calibration and the span calibration in this order.

4.4.1 Operational flow

The operational flow for manual calibration is described below:

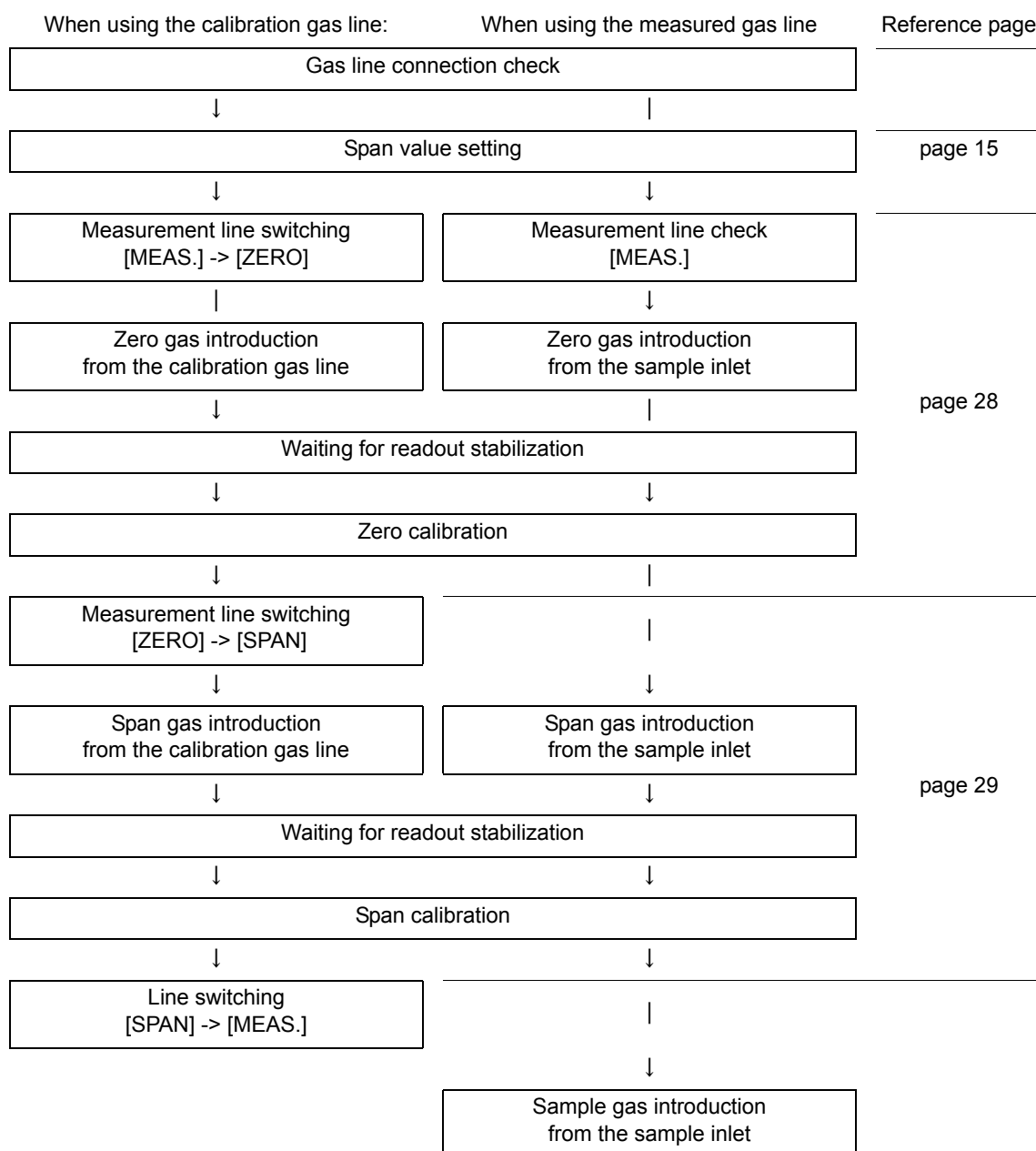

Note

Control the zero gas and span gas feed pressures at atmospheric pressure plus (0 kPa to 0.5 kPa).

4.4.2 Zero calibration

1. On the CAL. screen, check that the proper measurement line is selected.
If necessary, press the displayed MODE setting on the CAL. screen to display the MODE screen, and then change the setting and press the [SET] key on the MODE screen.

When using the calibration gas line: Select [ZERO].

When using the measured gas line: Select [MEAS.].

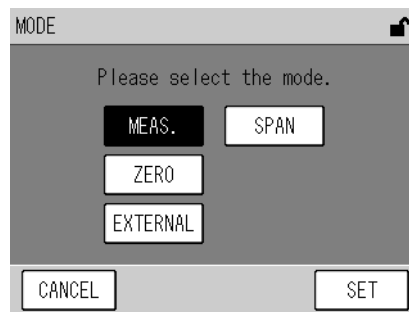

Fig. 35 MODE screen

2. When using the measured gas line, supply the zero gas from the sample gas inlet.
3. Wait for the readouts to be stabilized and then press the [ZERO] key on the CAL. screen. The zero calibration message will appear.

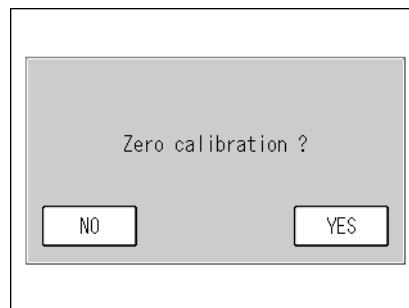

Fig. 36 Zero calibration message

Note

The [ZERO SET] key on the CAL. screen is valid only when MODE is set to MEAS. or ZERO.

4. Press the [YES] button. The zero calibration will be started. After the calibration is completed, the zero calibration coefficient will be updated and the CAL. screen will be displayed again.

Tip

To return the CAL. screen without executing zero calibration, press the [NO] button of the zero calibration message.

Note

If the result of the zero calibration deviates from the allowable range of zero calibration ($\pm 3,500$ counts), the ZERO (zero calibration) alarm occurs (see "8.2 Alarm List" (page 71)) and the zero calibration coefficient is not updated. In this case, the zero calibration coefficient displayed on the CAL. screen blinks. And if the standard output terminal block is provided, the alarm contact signal is outputted. See the rear panel signal table at the end of this document.

4.4.3 Span calibration

1. On the CAL. screen, check that the proper measurement line is selected.
If necessary, press the displayed MODE setting on the CAL. screen to display the MODE screen, and then change the setting and press the [SET] key on the MODE screen.

When using the calibration gas line: Select [SPAN].

When using the measured gas line: Select [MEAS.].

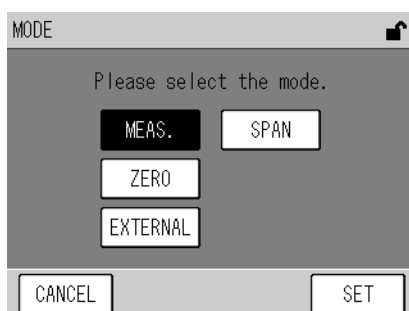

Fig. 37 MODE screen

2. When using the measured gas line, supply the span gas from the sample gas inlet.
3. Wait for the readouts to be stabilized and then press the [SPAN] key on the CAL. screen. The span calibration message will appear.



Fig. 38 Span calibration message

Note

The [SPAN SET] key on the CAL. screen is valid only when MODE is set to MEAS. or SPAN.

4. Press the [YES] button. The span calibration will be started. After the calibration is completed, the span calibration coefficient will be updated and the CAL. screen will be displayed again.

Tip

To return the CAL. screen without executing span calibration, press the [NO] button of the span calibration message.

Note

If the result of the NO or NO_x span calibration deviates from the allowable range of span calibration (0.5 to 2.0), the SPAN (span calibration) alarm occurs (see "8.2 Alarm List" (page 71)) and the span calibration coefficient is not updated. In this case, the span calibration coefficient displayed on the CAL. screen blinks. And if the standard output terminal block is provided, the alarm contact signal is outputted. See the rear panel signal table at the end of this document.

4.4.4 Finishing calibration

1. When using the calibration gas line, display the MODE screen and change the measurement line to [MEAS.].
When using the measured gas line, supply the sample gas to the measured gas line.
2. Press the [CLOSE] key on the CAL. screen. The MEAS. screen will be displayed again and the measurement will start.

5 DATA PROCESSING

Based on the acquired data, average, integration, and rolling average values are calculated. These values can be checked on the screen.

To check the data, press the [MENU] key on the MEAS. screen to display the MENU/DATA screen and then press the button of the data to be displayed.

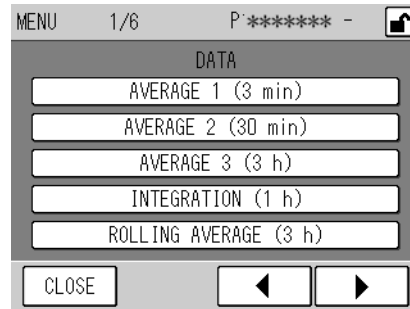

Fig. 39 MENU/DATA screen

The buttons allow you to perform the following operations.

[AVERAGE 1] to [AVERAGE 3]:

Displays the corresponding AVERAGE screen (see “5.1 Average” (page 34)).

[INTEGRATION]: Displays the INTEGRATION screen (see “5.2 Integration” (page 36)).

[ROLLING AVERAGE]:

Displays the ROLLING AVERAGE screen (see “5.3 Rolling Average” (page 38)).

● Screens for data check

The common functionalities of the screens for data check are described below:

On the MENU/DATA screen, press the button of the data to be displayed. The following screen for data check will be displayed.

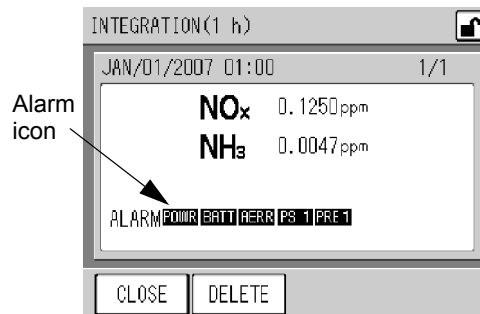

Fig. 40 AVERAGE screen (AVERAGE 1)

Immediately after this screen is opened, the latest calculation results are displayed.

The keys allow you to perform the following operations.

[CLOSE]: Returns to the MENU/DATA screen.

[DELETE]: Displays the message confirming data deletion (Fig. 42 on page 33).
This button is hidden when the keys are locked.

[◀]: Displays the previous page.

When the page of the oldest records is displayed, pressing this key displays the page of the latest records.

[▶]: Displays the next page.

When the page of the latest records is displayed, pressing this key displays the page of the oldest records.

Note

- If the displayed data was acquired when an alarm occurred, the alarm icon is displayed.
For the details of the alarm icon, see page 70.
- If no data is recorded, the following message appears:

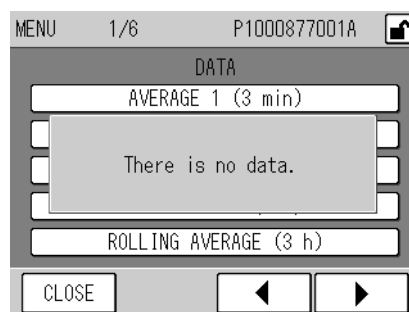

Fig. 41 Message when no data is recorded

● Deleting data

All the records of the calculated average and integration data can be deleted at a time. As for the rolling average data, the currently calculated one can be deleted.

1. Check that the keys are unlocked (Fig. 11 on page 8).
If the keys are locked, unlock them (see “6.7 Key Lock” (page 65)).
2. Display the data to be deleted on the screen for data check, and press the [DELETE] key. The message confirming data deletion will appear.

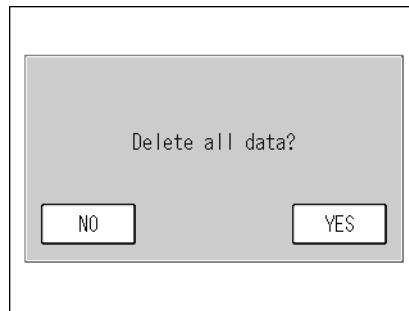

Fig. 42 Message confirming data deletion

3. Press the [YES] button. The message of deleting data will be displayed and the data deletion will start. After the data deletion is completed, the screen for data check will be displayed again.

Note

To return the screen for data check without deleting the data, press the [NO] button.



Fig. 43 Message of deleting data

5.1 Average

An average data is calculated by summing the measured values (momentary values) acquired every 1 second for a specified calculation period, and then dividing the cumulative total by the data counts.

There are three AVERAGE data (AVERAGE 1 to AVERAGE 3), calculated using different calculation periods. And these calculation results can be checked on the respective AVERAGE screens.

Table 1 AVERAGE types

Data	Calculation period	Recorded data capacity
AVERAGE 1	3 min	1000 data
AVERAGE 2	30 min	1000 data
AVERAGE 3	3 h	100 data

Note

- If the data counts exceeds the data capacity, the oldest data will be automatically deleted.
- The time displayed on the AVERAGE screen is the final data acquisition time.

Pressing the [AVERAGE 1], [AVERAGE 2], or [AVERAGE 3] on the MENU/DATA screen displays the screen showing the latest data.

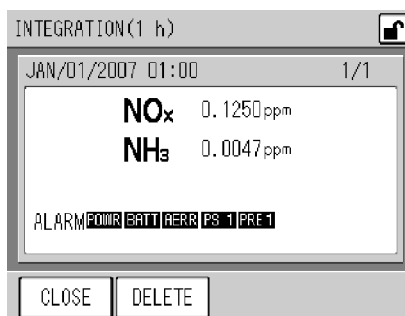

Fig. 44 AVERAGE screen (AVERAGE 1)

If an alarm occurs within the calculation period, the alarm record is also displayed with the data.

Note

- For the details of alarms, see "8.2 Alarm List" (page 71).
- A maximum of 16 alarms can be displayed in chronological order.
If the 17th or later alarms occur within the same calculation period, these alarms are not displayed.

For the other screen functionalities, see page 32.

● Average calculation

The timing of average calculation start or end is based on the internal clock.

If power shutdown occurs or if the internal clock is put forward:

The momentary data during the power shutdown or the put-forwarded time period will be regarded as missing.

If all the momentary values during the calculation period are missing, no average data will be recorded.

If power shutdown occurs before the data is saved or while the average, integration, or rolling average data is displayed, no data will be recorded.

If the internal clock is put back:

The subsequent operation depends upon the corrected time.

If the corrected time is the same as or later than the start time of the ongoing integration calculation, the integration calculation will go on.

If the corrected time is earlier than the start time of the ongoing integration calculation, the integration results up to now will be discarded and new integration calculation will start.

If the data that now being saved and an existing data have the same creation time:

The existing data will be overwritten with the new one (the existing data will be deleted).

5.2 Integration

An integration data is calculated by dividing the measured values (momentary values) acquired every 1 second by 3600 and summing these data for a specified calculation period.

This calculation result can be checked on the INTEGRATION screen.

The calculation period is 1 hour, and the data capacity is 1000 data.

Note

- If the data counts exceeds the data capacity, the oldest data will be automatically deleted.
- The time displayed on the INTEGRATION screen is the final data acquisition time.

Pressing the [INTEGRATION] on the MENU/DATA screen displays the screen showing the latest data.

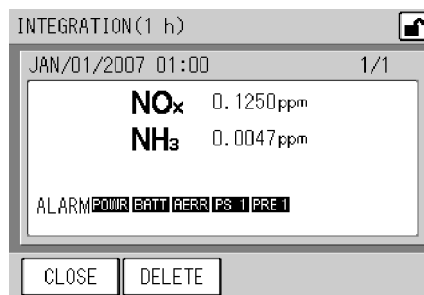

Fig. 45 INTEGRATION screen

If an alarm occurs within the calculation period, the alarm record is also displayed with the data.

Note

- For the details of alarms, see "8.2 Alarm List" (page 71).
- A maximum of 16 alarms can be displayed in chronological order.
If the 17th or later alarms occur within the same calculation period, these alarms are not displayed.

For the other screen functionalities, see page 32.

● Integration calculation

In the case of the standard specification, the timing of the integration calculation start and end is controlled by sending the ON signal to the integration value reset input (RST input) on the signal connection terminal block (see “6.5.3 Integration reset setting” (page 57)), or by receiving the integration calculation reset command via serial communication (refer to the instruction manual of Serial Communication).

These signal input and command reception are called external integration reset.

Once external integration reset is performed, the following action will occur automatically.

The internal clock time will be adjusted to the integration reset time nearest to the current time.

(For the standard specification, the default integration reset time is 00 min every hour. It can be set to 30 min every hour.)

If the adjusted time is the same as the expected reset time of the ongoing integration, the integration result will be recorded at that time and then the integration value output will be reset to zero (integration reset).

If the external integration reset is not performed after the time of the ongoing integration end + the waiting time for integration reset (3 min for the standard specification, 6 min for special specification) :

The integration result will be recorded at that time and then the integration value output will be reset to zero (integration reset). The internal clock will not be adjusted.

If the internal clock is put back:

The subsequent operation depends upon the corrected time.

If the corrected time is the same as or later than the start time of the ongoing integration calculation, the integration calculation will go on.

If the corrected time is earlier than the start time of the ongoing integration calculation, the integration results up to now will be discarded and new integration calculation will start.

If the data that now being saved and an existing data have the same creation time:

The existing data will be overwritten with the new one (the existing data will be deleted).

If an existing data has the creation time later than that of the data now being saved:

The data having the later creation time will be deleted.

5.3 Rolling Average

The rolling average value between the current time and the 3-hour earlier point is sequentially displayed on the ROLLING AVERAGE screen as time passes.

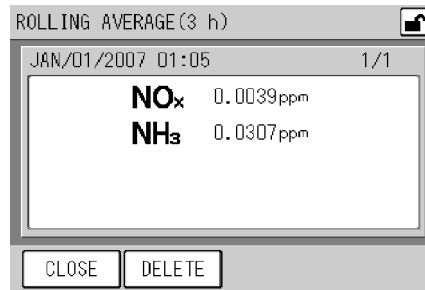

Fig. 46 ROLLING AVERAGE screen

For the screen functionalities, see page 32.

● Rolling average calculation

The momentary value at that point is used for this calculation.

If power shutdown occurs:

The momentary values during the shutdown period will be regarded as missing.

6 FUNCTIONALITIES

The MEAS. screen allows you to use the following functionalities:

By starting with the [MENU] key:

- Displaying average, integration, and rolling average values (see page 31)
- Displaying history (see page 40)
- Checking/adjusting analog output (see page 43)
- Checking analog input (see page 48)
- Checking/setting the maintenance status (see page 49)
- Setting the analog output range (see page 50)
- Setting the current time (see page 54)
- Setting the AIC (see page 17)
- Setting the AIC sequence (see page 23)
- Specifying a unit conversion factor (see page 55)
- Selecting the integration reset (see page 57)
- Setting the LCD (see page 58)
- Specifying a password (see page 61)
- Turning ON/OFF the ozone lamp (see page 63)
- Saving data in the memory (see page 64)

By starting with the [KEY LOCK] button:

- Locking/unlocking the keys (see page 65)

● MENU screens

Pressing the [MENU] key on the MEAS. screen allows you to use functionalities such as data review and settings.

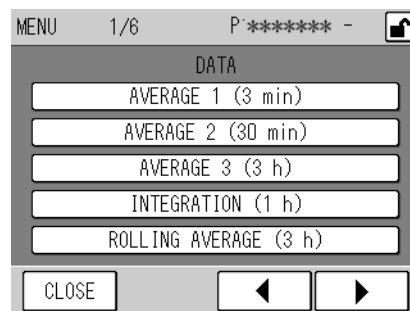

Fig. 47 MENU screen (DATA)

The following six different MENU screens are available:

- DATA (Fig. 39 on page 31)
- HISTORY (Fig. 48 on page 40)
- MAINTENANCE (Fig. 54 on page 43)
- RANGE (Fig. 61 on page 50)
- SETTING (Fig. 66 on page 53)
- SYSTEM (Fig. 71 on page 58)

The MENU/DATA screen always appears first.

The keys allow you to perform the following operations (common to all MENU screens).

- [CLOSE]: Returns to the MEAS. screen.
- [◀]: Displays the previous page.
- [▶]: Displays the next page.

6.1 Data Menu

The DATA menu allows you to display average, integration, and rolling average data. For further information on the MENU/DATA screen, see “5 DATA PROCESSING” (page 31).

6.2 History Menu

The HISTORY menu is used to display the calibration history and alarm history.



Fig. 48 MENU/HISTORY screen

The buttons allow you to perform the following operations.

[CAL. ADJUSTMENT HISTORY]:

Displays the CAL. ADJUSTMENT HISTORY screen (Fig. 52 on page 42).

[ALARM HISTORY]:

Displays the ALARM HISTORY screen (Fig. 53 on page 42).

● Operation of the HISTORY screens

The common functionalities to the HISTORY screens are described below:

On the MENU/HISTORY screen, press the button for the history to be displayed. The following HISTORY screen will be displayed.

DATE/TIME	COMP.	CAL.	VALUE
JAN/01/2007 01:13	NO _x	SPAN	1.0105
JAN/01/2007 01:13	NO _x +N	SPAN	.98120
JAN/01/2007 01:13	NO _x +N	ZERO	100
JAN/01/2007 01:13	NO _x	ZERO	18
JAN/01/2007 01:12	NO _x	SPAN	1.0120
JAN/01/2007 01:11	NO _x +N	SPAN	.98000
JAN/01/2007 01:11	NO _x +N	ZERO	101

Fig. 49 HISTORY screen (CAL. ADJUSTMENT)

The latest history is always displayed first.

The keys allow you to perform the following operations.

- [CLOSE]: Returns to the MENU/HISTORY screen.
- [DELETE]: Displays the message confirming data deletion (Fig. 50 on page 41).
- [◀]: Displays the previous page.
When the page of the oldest records is displayed, pressing this key displays the page of the latest records.
- [▶]: Displays the next page.
When the page of the latest records is displayed, pressing this key displays the page of the oldest records.

Note

- The [DELETE] key is hidden when the keys are locked.
- The [◀] and [▶] keys are hidden when the data is within one page (up to 7 data).

Deleting history

All the recorded histories may be deleted at a time.

1. Press the [DELETE] key on the HISTORY screen including the histories to be deleted. A message will appear confirming the data deletion.

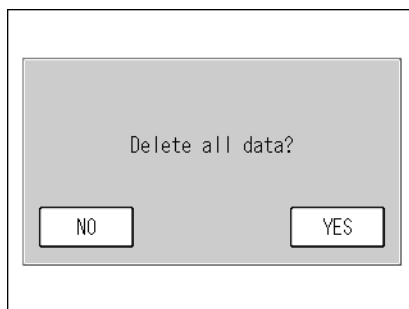

Fig. 50 Message confirming data deletion

2. Press the [YES] button. The message of deleting data will be displayed and the data deletion will start. After the data deletion is completed, the HISTORY screen will be displayed again.

Note

To return the HISTORY screen without deleting the data, press the [NO] button.



Fig. 51 Message of deleting data

6.2.1 Calibration history

Press the [CAL. ADJUSTMENT HISTORY] button on the MENU/HISTORY screen. The latest calibration history will be displayed.

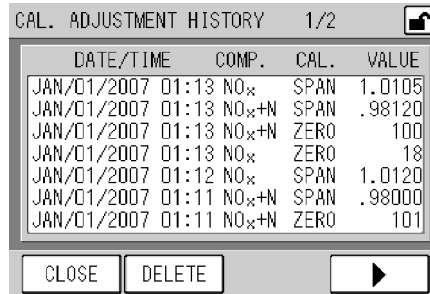

CAL. ADJUSTMENT HISTORY 1/2			
DATE/TIME	COMP.	CAL.	VALUE
JAN/01/2007 01:13	NO _x	SPAN	1.0105
JAN/01/2007 01:13	NO _x +N	SPAN	.98120
JAN/01/2007 01:13	NO _x +N	ZERO	100
JAN/01/2007 01:13	NO _x	ZERO	18
JAN/01/2007 01:12	NO _x	SPAN	1.0120
JAN/01/2007 01:11	NO _x +N	SPAN	.98000
JAN/01/2007 01:11	NO _x +N	ZERO	101

CLOSE DELETE [Next]

Fig. 52 CAL. ADJUSTMENT HISTORY screen

For the screen functionalities, see page 40.

6.2.2 Alarm history

Press the [ALARM HISTORY] button on the MENU/HISTORY screen. The latest alarm history will be displayed.

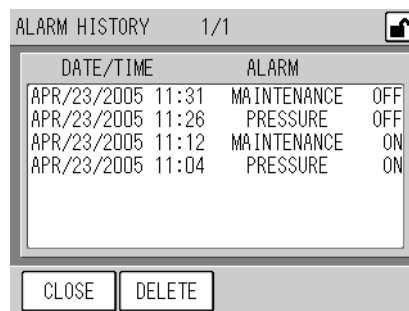

ALARM HISTORY 1/1		
DATE/TIME	ALARM	
APR/23/2005 11:31	MAINTENANCE	OFF
APR/23/2005 11:26	PRESSURE	OFF
APR/23/2005 11:12	MAINTENANCE	ON
APR/23/2005 11:04	PRESSURE	ON

CLOSE DELETE

Fig. 53 ALARM HISTORY screen

For the screen functionalities, see page 40.

6.3 Maintenance Menu

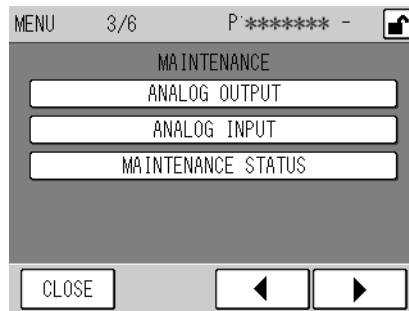

Fig. 54 MENU/MAINTENANCE screen

The keys allow you to perform the following operations.

- [ANALOG OUTPUT]: Displays the ANALOG OUTPUT screen (Fig. 55 on page 43).
- [ANALOG INPUT]: Displays the ANALOG INPUT screen (Fig. 58 on page 48).
- [MAINTENANCE STATUS]: Displays the MAINTENANCE STATUS screen (Fig. 59 on page 49).

6.3.1 Analog output

Press the [ANALOG OUTPUT] button on the MENU/MAINTENANCE screen. The ANALOG OUTPUT screen will be displayed.

This screen allows you to check and control the analog output.

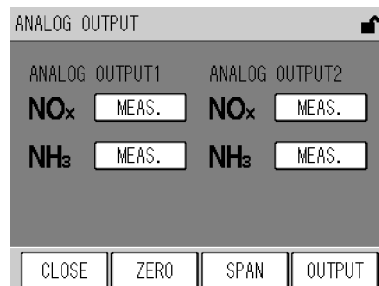

Fig. 55 ANALOG OUTPUT screen

The current output modes of ANALOG OUTPUT 1 (momentary value) and ANALOG OUTPUT 2 (which varies depending on the specification; integration value for the standard specification) are displayed as buttons.

- [MEAS.]: The current measured value is being outputted. This is normal mode.
- [XX%]: XX% of the full scale is being outputted. The settable value is between 0% (example: about 0 V) and 100% (example: about 1 V) in steps of 10%.

Note

All outputs are always in the [MEAS.] mode (the current measured value is being outputted) first.

The buttons allow you to select and check the output modes (see below).
 The keys allow you to perform the following operations.

- [CLOSE]: Returns to the MENU/MAINTENANCE screen.
- [ZERO]: Displays the DA ADJUST/ ZERO screen for zero calibration of analog output (Fig. 56 on page 45).
- [SPAN]: Displays the DA ADJUST/ SPAN screen for span calibration of analog output (Fig. 57 on page 46).
- [OUTPUT]: Outputs the selected output via the analog output terminal.

● **Checking output**

1. On the ANALOG OUTPUT screen, press the button of the output mode to be changed.

With every pressing of the button, the button display and the actual output mode are automatically changed in the following order:

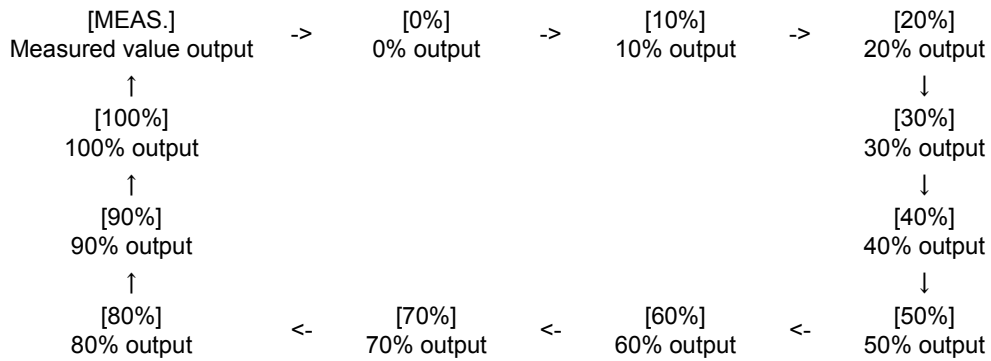

2. To finish output check, press the [CLOSE] key to return to the MENU/ MAINTENANCE screen.

Note

Pressing the [CLOSE] key will put all the output back to the measured values.

● Adjusting the zero output and span output

Zero output adjustment

1. Output [0%] on the ANALOG OUTPUT screen and then press the [ZERO] key. The DA ADJUST/ ZERO screen will be displayed.

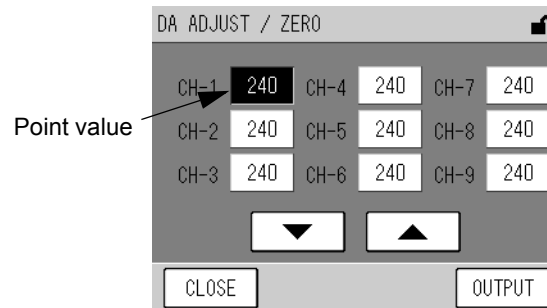

Fig. 56 DA ADJUST/ ZERO screen

The respective output point values of the channels are displayed.

The outputs allocated to the channels are as follows:

CH	Analog output	Terminal
CH-1	Non-insulated output of NO _x momentary value (0 V to 1 V) (ANALOG OUTPUT 1)	C1 — C4
CH-2	Non-insulated output of NH ₃ momentary value (0 V to 1 V) (ANALOG OUTPUT 1)	C2 — C4
CH-3	Non-insulated output of NO _x + NH ₃ momentary value (0 V to 1 V) (ANALOG OUTPUT 1)	C3 — C4
CH-4	Insulated output of NO _x momentary value (0 V to 1 V) (ANALOG OUTPUT 2)	A8 — A9
CH-5	Insulated output of NH ₃ momentary value (0 V to 1 V) (ANALOG OUTPUT 2)	A10 — A11
CH-6	Insulated output of NO _x + NH ₃ momentary value (0 V to 1 V) (ANALOG OUTPUT 2)	A12 — A13
CH-7	Non-insulated output of NO _x rolling average value (0 V to 1 V) (ANALOG OUTPUT 2)	C5 — C8
CH-8	Non-insulated output of NH ₃ rolling average value (0 V to 1 V) (ANALOG OUTPUT 2)	C6 — C8
CH-9	Non-insulated output of NO _x + NH ₃ rolling average value (0 V to 1 V) (ANALOG OUTPUT 2)	C7 — C8

Tip

For the terminal block output, see the rear panel signal table at the end of this document.

Press a point value button, and the button will be highlighted.

In this state, the following buttons allow you to perform the following operations.

- [▲]: Increases the point value for the selected channel. A 10-point increment increases the output about 3 mV.
- [▼]: Decreases the point value for the selected channel. A 10-point decrement decreases the output about 3 mV.

The keys allow you to perform the following operations.

[CLOSE]: Returns to the ANALOG OUTPUT screen.

[OUTPUT]: Establishes each point value.

2. Press the point value button for the channel to be adjusted. The selected point value will be highlighted.
3. Change the point value by pressing the [▲] or [▼] button.
4. To establish all the point values, press the [OUTPUT] key.
5. Press the [CLOSE] key to return to the ANALOG OUTPUT screen (Fig. 55 on page 43).
6. Check the output (page 44). If necessary, repeat the above steps to make readjustment.

Span output adjustment

1. Output [100%] on the ANALOG OUTPUT screen and then press the [SPAN] key. The DA ADJUST/ SPAN screen will be displayed.

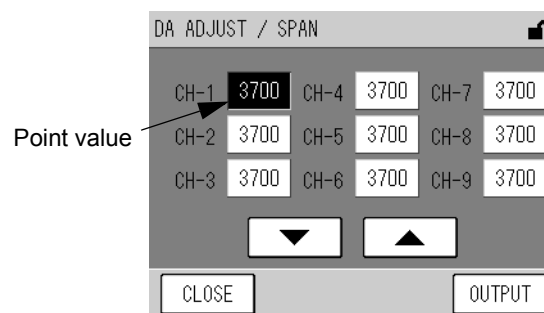

Fig. 57 DA ADJUST/ SPAN screen

The respective output point values of the channels are displayed.

The outputs allocated to the channels are as follows:

CH	Analog output	Terminal
CH-1	Non-insulated output of NO _x momentary value (0 V to 1 V) (ANALOG OUTPUT 1)	C1 — C4
CH-2	Non-insulated output of NH ₃ momentary value (0 V to 1 V) (ANALOG OUTPUT 1)	C2 — C4
CH-3	Non-insulated output of NO _x + NH ₃ momentary value (0 V to 1 V) (ANALOG OUTPUT 1)	C3 — C4
CH-4	Insulated output of NO _x momentary value (0 V to 1 V) (ANALOG OUTPUT 2)	A8 — A9
CH-5	Insulated output of NH ₃ momentary value (0 V to 1 V) (ANALOG OUTPUT 2)	A10 — A11
CH-6	Insulated output of NO _x + NH ₃ momentary value (0 V to 1 V) (ANALOG OUTPUT 2)	A12 — A13
CH-7	Non-insulated output of NO _x rolling average value (0 V to 1 V) (ANALOG OUTPUT 2)	C5 — C8
CH-8	Non-insulated output of NH ₃ rolling average value (0 V to 1 V) (ANALOG OUTPUT 2)	C6 — C8
CH-9	Non-insulated output of NO _x + NH ₃ rolling average value (0 V to 1 V) (ANALOG OUTPUT 2)	C7 — C8

Tip

For the terminal block output, see the rear panel signal table at the end of this document.

Press a point value button, and the button will be highlighted.

In this state, the following buttons allow you to perform the following operations.

- [▲]: Increases the point value for the selected channel. A 10-point increment increases the output about 3 mV.
- [▼]: Decreases the point value for the selected channel. A 10-point decrement decreases the output about 3 mV.

The keys allow you to perform the following operations.

- [CLOSE]: Returns to the ANALOG OUTPUT screen.
- [OUTPUT]: Establishes each point value.

2. **Press the point value button for the channel to be adjusted. The selected point value will be highlighted.**
3. **Change the point value by pressing the [▲] or [▼] button.**
4. **To establish all the point values, press the [OUTPUT] key.**
5. **Press the [CLOSE] key to return to the ANALOG OUTPUT screen (Fig. 55 on page 43).**
6. **Check the output (page 44). If necessary, repeat the above steps to make readjustment.**

6.3.2 Analog input

Press the [ANALOG INPUT] button on the MENU/MAINTENANCE screen. The ANALOG INPUT screen will be displayed.

This screen, which shows the analog input values, is used to check the statuses of analog signals inputted from the sensor and others.

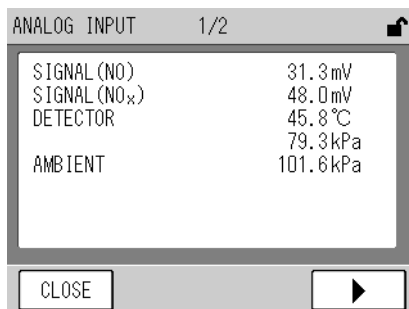

Fig. 58 ANALOG INPUT screen

The analog input values are listed across 2 pages.

The keys allow you to perform the following operations.

[CLOSE]: Returns to the MENU/MAINTENANCE screen.

[◀]: Displays the previous page.

[▶]: Displays the next page.

The displayed items and its units are shown below:

Signal name	Unit	Description
SIGNAL(NO _x)	mV	Voltage of the measured NO _x value
SIGNAL (NO _x + NH ₃)	mV	Voltage of the measured NO _x + NH ₃ value
DETECTOR	°C	Detector temperature Standard value: 43°C ±5°C
	kPa	Detector pressure
AMBIENT	kPa	Current atmospheric pressure
SAMPLE	L/min	Sample flow rate (optional) Standard value: 1.1 L/min ±0.3 L/min
DC 24V	V	Power supply voltage inside the APNA-370 Standard value: 24 V ±0.5 V
DC 5V	V	Power supply voltage inside the APNA-370 Standard value: 5 V ±0.5 V

6.3.3 Maintenance status

Press the [MAINTENANCE STATUS] button on the MENU/MAINTENANCE screen. The MAINTENANCE STATUS screen will be displayed.

This screen shows the cumulative operating hours of consumables.

If you reset this counts when replacing the corresponding consumables, the displayed count will help you determine the approximate time of the next replacement.

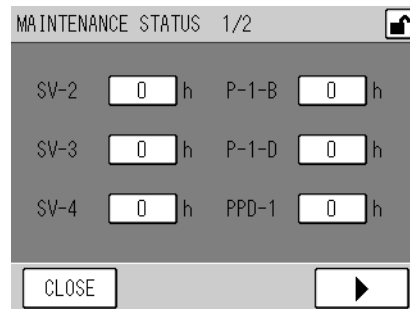

Fig. 59 MAINTENANCE STATUS screen

The operating hours of consumable parts are displayed across 2 pages.

For the symbols, see the flow sheet at the end of this document.

Use P-1-B for the pump itself and P-1-D for the pump diaphragm.

The following keys allow you to perform the following operations.

[CLOSE]: Returns to the MENU/MAINTENANCE screen.

[◀]: Displays the previous page.

[▶]: Displays the next page.

● Changing the operating hours (resetting)

1. Press the button of the operating hour to be changed (reset).

The MAINTENANCE STATUS screen for setting will be displayed.

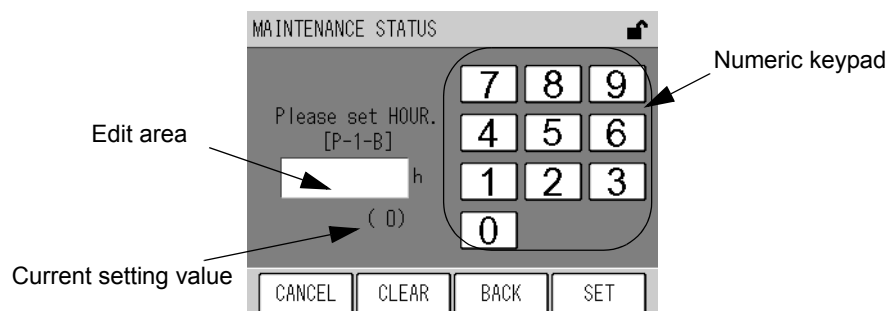

Fig. 60 MAINTENANCE STATUS screen for setting

Enter a value via the numeric keypad.

The keys allow you to perform the following operations.

[CANCEL]: Returns to the MAINTENANCE STATUS screen without changing the time.

[CLEAR]: Deletes the value entered in the edit area.

[BACK]: Deletes the just entered figure (1-digit).

[SET]: Returns to the MAINTENANCE STATUS screen with the time changed.

2. Enter a desired value (0 for resetting) via the numeric keypad.

3. Press the [SET] key. The operating hours will be changed (reset) and the MAINTENANCE STATUS screen is displayed again.

6.4 Range Menu

The MENU/RANGE screen is used to change the analog output ranges by changing the full-scale setting.

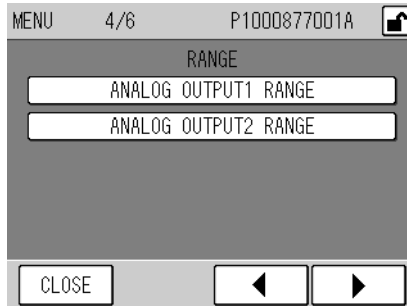

Fig. 61 MENU/RANGE screen

The buttons allow you to perform the following operations.

- [ANALOG OUTPUT1 RANGE]: Displays the ANALOG OUTPUT1 RANGE screen (Fig. 64 on page 52).
- [ANALOG OUTPUT2 RANGE]: Displays the ANALOG OUTPUT2 RANGE screen (Fig. 65 on page 52).

● ANALOG OUTPUT RANGE screens

The common functionalities to the ANALOG OUTPUT RANGE screens are described below: On the RANGE MENU screen, press the button of the range to be changed. The following ANALOG OUTPUT RANGE screen will be displayed.

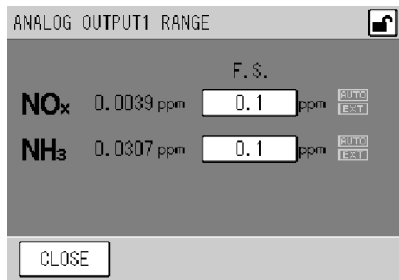

Fig. 62 ANALOG OUTPUT RANGE screen (ANALOG OUTPUT1)

This screen shows the current range status of each analog output signal.

- [XXXX]: The range is currently set to XXXX ppm. Pressing this button allows you to change the range setting (see page 51).

The currently used range type is displayed on the right of the range display.

- AUTO: The automatic range switching is selected.
- EXT: The external range switching is selected.

The following key allows you to perform the following operations.

[CLOSE]: Returns to the MENU/HISTORY screen.

Tip

Automatic range switching operation (for the standard specification)

The combinations used for the automatic range switching depends upon the specification.

For the standard specification, all of the fixed ranges are used.

The analog output range for which the auto range switching is set changes automatically as follows:

- When the reading exceeds 90% of the current range, the measurement range will be switched to the next higher range.
 - If the reading drops below 80% of the next lower range of the current one, the measurement range will be switched to the lower range.
-

● **Changing range setting**

1. On the ANALOG OUTPUT RANGE screen, press the button of the range to be changed. The RANGE screen will be displayed.

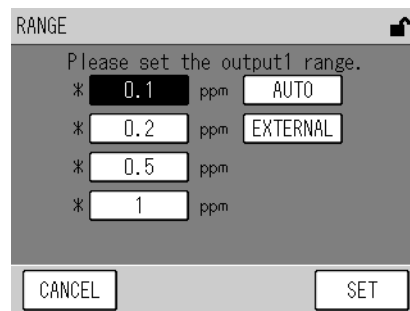

Fig. 63 RANGE screen (OUTPUT 1)

The range is set by choosing a button of range setting.

The keys allow you to perform the following operations.

[CANCEL]: Returns to the ANALOG OUTPUT RANGE screen without changing the settings.

[SET]: Returns to the ANALOG OUTPUT RANGE screen with the settings changed.

Tip

Among the fixed ranges, the ones for which an asterisk (*) is displayed on the left of the button are available for the auto range switching. The combinations used for the automatic range switching depends upon the specification. For the standard specification, all of the fixed ranges are used.

2. Press the button of the range to be set.

Note

To use the external signal for range switching, select [EXTERNAL]. The external selection contact is optionally available.

3. Press the [SET] key. The range setting will be changed and the ANALOG OUTPUT RANGE screen is displayed again.

6.4.1 ANALOG OUTPUT 1 range (momentary value)

Press the [ANALOG OUTPUT 1 RANGE] button on the MENU/RANGE screen. The ANALOG OUTPUT1 RANGE screen will be displayed.

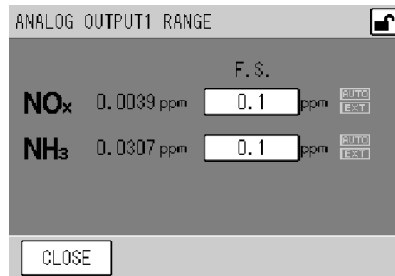

Fig. 64 ANALOG OUTPUT1 RANGE screen

For the screen functionalities, see page 50.

6.4.2 ANALOG OUTPUT 2 range (rolling average)

Press the [ANALOG OUTPUT 2 RANGE] button on the MENU/RANGE screen. The ANALOG OUTPUT2 RANGE screen will be displayed.

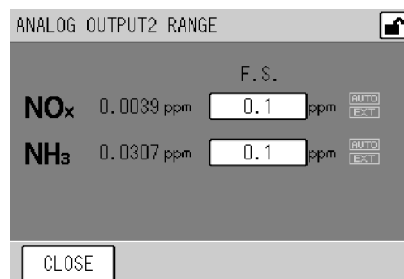

Fig. 65 ANALOG OUTPUT2 RANGE screen

For the screen functionalities, see page 50.

Note

For the analog output range, either the momentary value and rolling average (standard) or the momentary value and average value (optional) can be selected.

6.5 Setting Menu

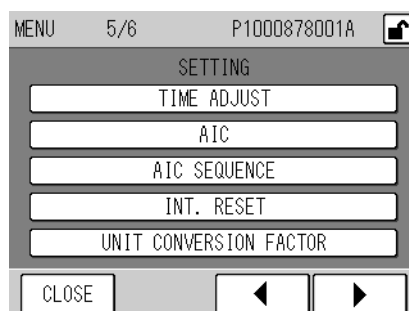

Fig. 66 MENU/SETTING screen

The buttons allow you to perform the following operations.

- [TIME ADJUST]: Displays the TIME ADJUSTMENT screen (Fig. 67 on page 54).
- [AIC]: Displays the AIC screen (Fig. 20 on page 17).
- [AIC SEQUENCE]: Displays the AIC SEQUENCE screen (Fig. 28 on page 23).
- [INT. RESET]: Displays the INT. RESET SETTING screen (Fig. 70 on page 57).
- [UNIT CONVERSION FACTOR]: Displays the UNIT CONVERSION FACTOR screen (Fig. 68 on page 55).

6.5.1 Time adjustment

Press the [TIME ADJUST] button on the MENU/SETTING screen. The TIME ADJUST screen will be displayed. This screen allows you to adjust the internal clock.

Note

Since the adjustment of the internal clock affects the data recording, give precautionary attention (see page 19).

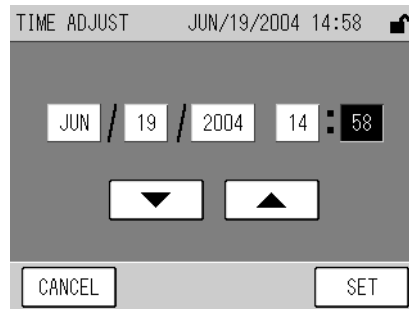

Fig. 67 TIME ADJUST screen

The current time setting is always displayed first, in a format of year, month, day, hour, and minute as respective buttons.

To change a value, press the corresponding button, and then press either of the following buttons to increase or decrease the value.

- [▲]: Increases the value.
- [▼]: Decreases the value.

The keys allow you to perform the following operations.

[CANCEL]: Returns to the MENU/SETTING screen without changing the settings.

[SET]: Returns to the MENU/SETTING screen with the settings changed.

Note

- If you press the [CANCEL] button before completing the setting, the time prior to the change will apply.
- The time cannot be set on a second basis. Pressing the [SET] key will automatically set the time to 00 second.
- If you change the time to any unrealistic date or time and press the [SET] key, the realistic date or time nearest to the set value will apply automatically.
- Pressing the [SET] button will delete the internal data (e.g., average) having the creation time later than the set time.

6.5.2 Unit conversion factor

Press the [UNIT CONVERSION FACTOR] button on the MENU/SETTING screen. The UNIT CONVERSION FACTOR screen will be displayed.

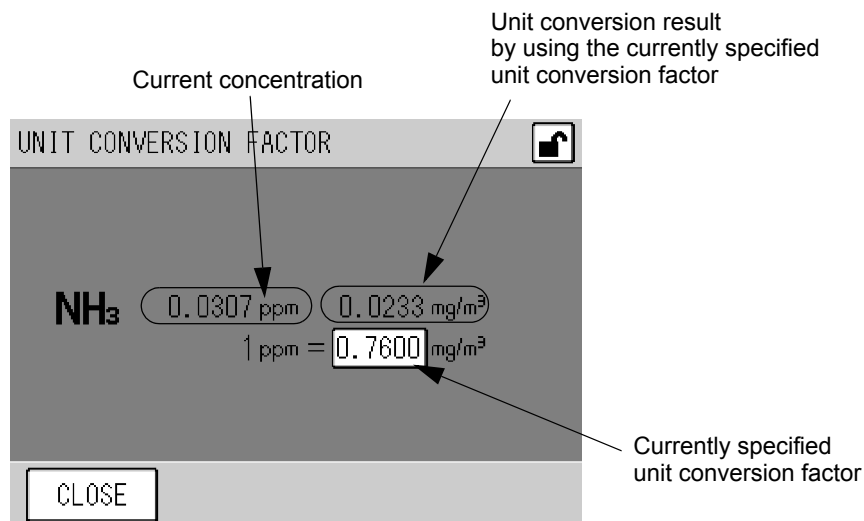

Fig. 68 UNIT CONVERSION FACTOR screen

For each measurement component, the current concentration and the conversion result by applying the currently selected unit conversion factor are displayed. This screen shows the current concentration in a different unit, and no setting on this screen affects the analog output and others.

The currently specified unit conversion factor is also displayed as a button.

To change the factor value, press the button of the factor to be changed (see page 56).

The following key allows you to perform the following operations.

[CLOSE]: Returns to the MENU/SETTING screen.

● **Changing the unit conversion factor**

1. Press the button of the unit conversion factor to be changed. The **UNIT CONVERSION FACTOR** screen for setting will be displayed.

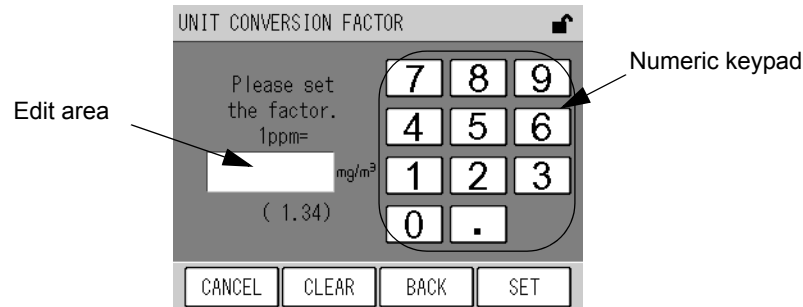

Fig. 69 UNIT CONVERSION FACTOR screen for setting

The currently select conversion factor is displayed in parentheses below the edit area.

Enter a value via the numeric keypad.

The keys allow you to perform the following operations.

- [CANCEL]: Returns to the UNIT CONVERSION FACTOR screen without changing the settings. The previous span gas concentration value will be used continuously.
- [CLEAR]: Deletes the value entered in the edit area
- [BACK]: Deletes the just entered figure (1-digit).
- [SET]: Returns to the UNIT CONVERSION FACTOR screen with the settings changed.

2. Enter a desired value via the numeric keypad.
3. Press the [SET] key. The factor will be changed and the **UNIT CONVERSION FACTOR** screen is displayed again.

6.5.3 Integration reset setting

Press the [INT. RESET] button on the MENU/SETTING screen. The INT. RESET SETTING screen will be displayed. This screen allows you to select a method for resetting the integration value, specify resetting time, and enable/disable the telemeter alarm.

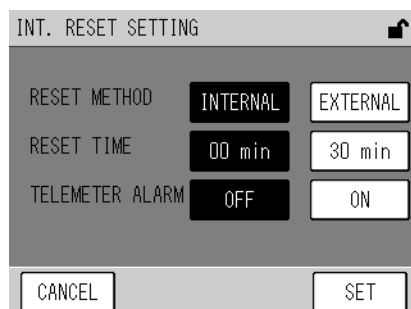

Fig. 70 INT. RESET SETTING screen

Item	Description
RESET METHOD	Select a method for resetting the integration value. INTERNAL: With the internal clock. EXTERNAL: With the external signal input.
RESET TIME	Specify the minute value to which the internal clock is adjusted at a integration reset. 00 min: The internal clock is adjusted to 00 min. 30 min: The internal clock is adjusted to 30 min.
TELEMETER ALARM	Specify whether or not to use the telemeter error signal. ON: The telemeter error signal is used. OFF: The telemeter error signal is not used.

Note

- When RESET METHOD is set to INTERNAL, no external reset signal will be accepted.
- If TELEMETER ALARM is set to ON, even when RESET METHOD is set to EXTERNAL and the telemeter error occurs (the telemeter error input contact is opened), the integration reset is performed with the internal clock. Besides, if AIC MODE is set to EXTERNAL (see “4.3.1 AIC setting” (page 17)), the AIC sequence will be started with the internal clock automatically.

6.5.4 AIC setting

For the AIC setting, see “4.3.1 AIC setting” (page 17).

6.5.5 AIC sequence setting

For setting the AIC sequence, see “4.3.3 Setting the AIC sequence” (page 23).

6.6 System Menu

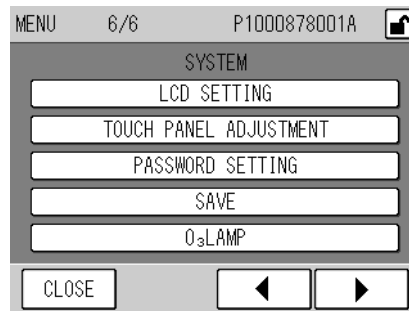

Fig. 71 MENU/SYSTEM screen

The buttons allow you to perform the following operations.

[LCD SETTING]: Displays the LCD SETTING screen (Fig. 72 on page 58).

[TOUCH PANEL ADJUSTMENT]:

Displays the TOUCH PANEL ADJUSTMENT screen (Fig. 74 on page 60).

[PASSWORD SETTING]:

Displays the PASSWORD SETTING screen (Fig. 76 on page 61).

[SAVE]:

Displays a message of saving data (Fig. 80 on page 64).

[O₃LAMP]:

Displays the O₃ LAMP screen (Fig. 79 on page 63).

6.6.1 LCD setting

Press the [LCD SETTING] button on the MENU/SYSTEM screen. The LCD SETTING screen will be displayed.

This screen allows you to set the time for automatic turning OFF of the LCD backlight and control the LCD brightness.

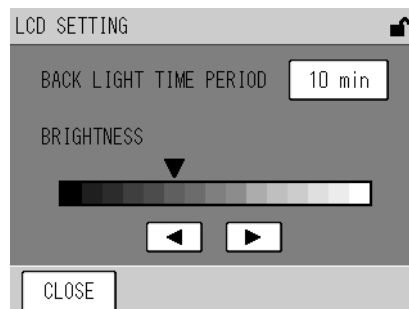

Fig. 72 LCD SETTING screen

The currently set time for automatic backlight OFF is displayed as a button.

[XX min]: Turns OFF the backlight after XX min (10 min, 20 min, or 30 min) from the last key operation.

[OFF]: Keeps the backlight illuminated.

To change the time setting, press the button of the time for automatic backlight OFF (see page 59).

The current brightness setting for the LCD is also displayed in position of the ▼ mark.

- **Setting the time for automatic backlight OFF**

1. Press the button of the time for automatic backlight OFF. The BACK LIGHT TIME PERIOD screen will be displayed.

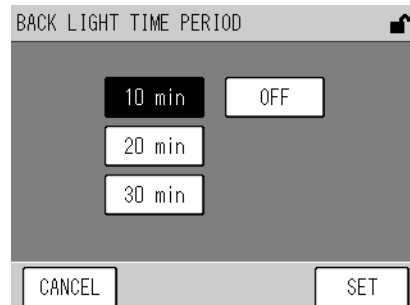

Fig. 73 BACK LIGHT TIME PERIOD screen

The time is set by choosing a button of time setting.
The keys allow you to perform the following operations.

[CANCEL]: Returns to the LCD SETTING screen without changing the settings.

[SET]: Returns to the LCD SETTING screen with the settings changed.

2. Press the button of the time to be set.
3. Press the [SET] key. The time setting for automatic backlight OFF will be changed and the LCD SETTING screen is displayed again.

- **Controlling the LCD brightness**

Use the following button to control the LCD brightness.

[◀]: Decreases the brightness level of the screen.

[▶]: Increases the brightness level of the screen.

6.6.2 Touch panel adjustment

Press the [TOUCH PANEL ADJUSTMENT] button on the MENU/SYSTEM screen.

The TOUCH PANEL ADJUSTMENT screen will be displayed.

If the displayed buttons and keys deviate from their respective touch positions, you can adjust the touch panel by performing the following steps.

Note

Such deviations on the touch panel can be adjusted within a range of 36 dots.

If the positions deviate exceeding this limit, the following steps cannot be performed. Contact us.

Adjustment procedure:

1. Press the [TOUCH PANEL ADJUSTMENT] button on the MENU/SYSTEM screen. The TOUCH PANEL ADJUSTMENT screen (1) will be displayed.
2. Press the center of the area framed by 4 small triangles.

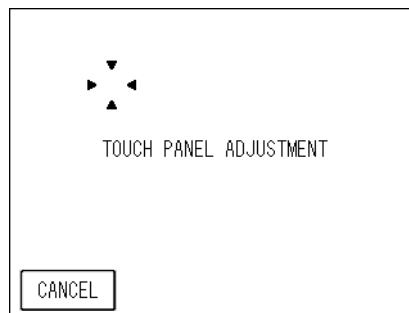

Fig. 74 TOUCH PANEL ADJUSTMENT screen (1)

3. The TOUCH PANEL ADJUSTMENT screen (2) will be displayed. Press the center of the area framed by 4 small triangles. The positions on the touch panel will be corrected and the MENU/SYSTEM screen will be displayed again.

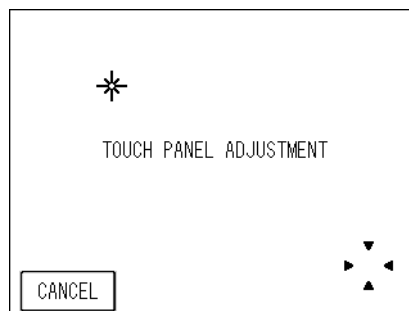

Fig. 75 TOUCH PANEL ADJUSTMENT screen (2)

6.6.3 Password setting

Note

The password is required to change the password.

1. Press the [PASSWORD SETTING] button on the MENU/SYSTEM screen.
The PASSWORD SETTING screen will be displayed.

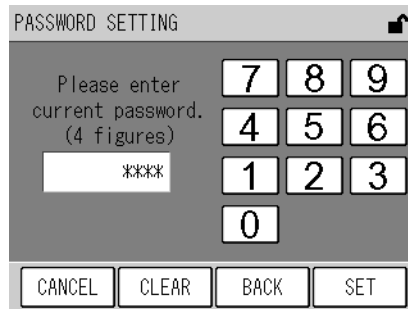

Fig. 76 PASSWORD SETTING screen (requiring the current password)

Enter a value via the numeric keypad.

The keys allow you to perform the following operations.

- [CANCEL]: Returns to the MENU/SYSTEM screen without changing the password.
- [CLEAR]: Deletes the value entered in the edit area
- [BACK]: Deletes the just entered figure (1-digit).
- [SET]: Changes the password to the value currently entered in the edit area.

2. Enter the current password in accordance with the message on the screen, and then press the [SET] key.

If the entered password is correct, a message will appear prompting you to enter a new password.

Note

If the entered password is not correct, the procedure for changing the password will be aborted and the MENU/SYSTEM screen is displayed again.

Tip

The default password is 1234.

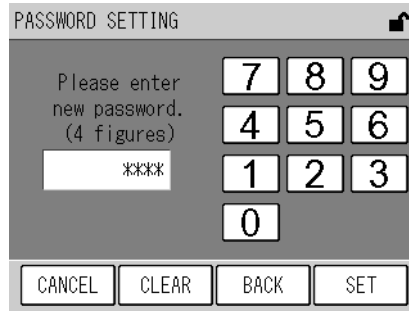

Fig. 77 PASSWORD SETTING screen (requiring a new password)

Enter a value via the numeric keypad.

The function of each key is the same as on the PASSWORD SETTING screen (requiring the current password) (Fig. 76 on page 61).

3. Enter a new 4-character password in accordance with the message displayed on the screen and then press the [SET] key. A message will appear prompting you to verify the new password.

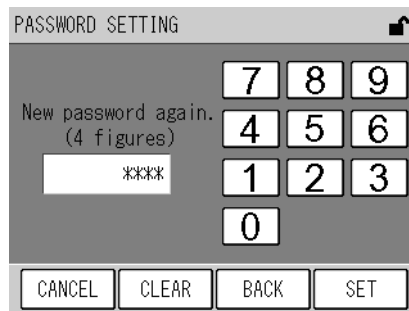

Fig. 78 PASSWORD SETTING screen (confirming a new password)

Enter a value via the numeric keypad.

The function of each key is the same as on the PASSWORD SETTING screen (requiring the current password) (Fig. 76 on page 61).

4. Enter the new 4-character password again in accordance with the message displayed on the screen and then press the [SET] key. If the re-entered password agrees with the new password, the current password will be changed and the MENU/SYSTEM screen is displayed again.

Note

If the re-entered password does not agree with the new password, the procedure for changing the current password will be aborted and the MENU/SYSTEM screen is displayed again. In this case, the password is not changed.

6.6.4 Turning ON/OFF the ozone lamp

Press the [O₃LAMP] button on the MENU/SYSTEM screen. The O₃ LAMP screen will be displayed.

This screen allows you to manually turn ON/OFF the ozone lamp.

Note

When the power is turned ON, the ozone lamp will be automatically turned ON.

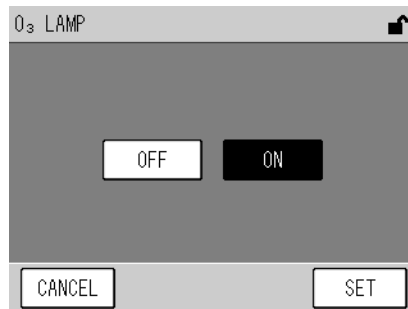

Fig. 79 O₃ LAMP screen

The buttons allow you to perform the following operations.

- [ON]: Selects starting generation of ozone.
Subsequently pressing the [SET] key will turn ON the ozone lamp and start generating ozone.
- [OFF]: Selects stopping generation of ozone.
Subsequently pressing the [SET] key will turn OFF the ozone lamp and stops generating ozone.

The keys allow you to perform the following operations.

- [CANCEL]: Cancels the operation and returns to the MENU/SYSTEM screen.
- [SET]: Executes the operation and returns to the MENU/SYSTEM screen.

Note

If the flow rate error, pressure error, or converter temperature error occurs, the ozone lamp will not be turned ON. Even if O₃ Lamp ON is displayed on the O₃ LAMP screen or MEAS. screen, the ozone lamp will be automatically turned OFF so far as the above error persists (Automatic O₃ lamp OFF function). Once the error is eliminated, the O₃ lamp will be automatically turned ON.

6.6.5 Data saving

To save data in the memory manually, press the [SAVE] button on the MENU/SYSTEM screen. Before turning OFF the APNA-370, be sure to perform this operation to save the data that has not yet been saved in the memory.

Note

- The average and integration values are stored in the flash memory every 10 minutes. Before turning OFF the power, be sure to save those data in the memory.
- If accidental power outage occurs, data during a period of 10 minutes maximum may not be recorded.

1. Press the [SAVE] button on the MENU/SYSTEM screen. The message confirming the saving of the data will appear.

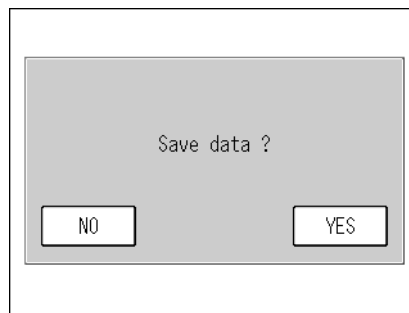

Fig. 80 Message confirming the saving of the data

The buttons allow you to perform the following operations.

[YES]: Saves the data in the memory.

[NO]: Saves no data to the memory and returns to the MENU/SYSTEM screen.

2. Press the [YES] button. The message of saving will be displayed and the data will start being saved. After the saving of the data is completed, the MENU/SYSTEM screen is displayed again.



Fig. 81 Message of saving

6.7 Key Lock

When the [KEY LOCK] at the upper right corner of the screen is displayed in a box, pressing the [KEY LOCK] button displays the KEY LOCK screen.

This screen allows you to lock/unlock the keys.

Note

The password is required to unlock the keys and to enter the supervisor mode.
For password setting, see “6.6.3 Password setting” (page 61).

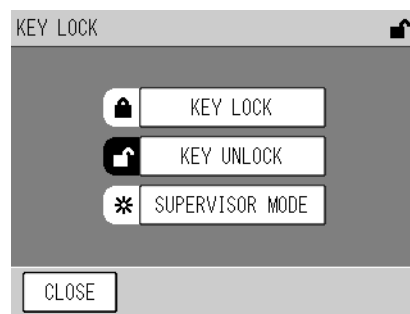

Fig. 82 KEY LOCK screen

When the keys are locked, the [KEY LOCK] icon is highlighted. When the keys are unlocked, the [KEY UNLOCK] icon is highlighted.

The buttons allow you to perform the following operations.

- | | |
|--------------------|----------------------------------------------------------------------------------------------------------------------------------------------------------------------------------------------------------------|
| [KEY LOCK]: | To lock the keys when the keys are unlocked, press this button. When the keys are locked, this button is invalid. |
| [KEY UNLOCK]: | To unlock the keys when the keys are locked, press this button, and then enter the correct password on the displayed PASSWORD screen (Fig. 83 on page 66). When the keys are unlocked, this button is invalid. |
| [SUPERVISOR MODE]: | Displays the PASSWORD screen (Fig. 83 on page 66). To enter the supervisor mode, which is used exclusively for our service maintenance, enter the correct password. |

● Entering the password

1. Select a button on the KEY LOCK screen. The PASSWORD screen will be displayed.

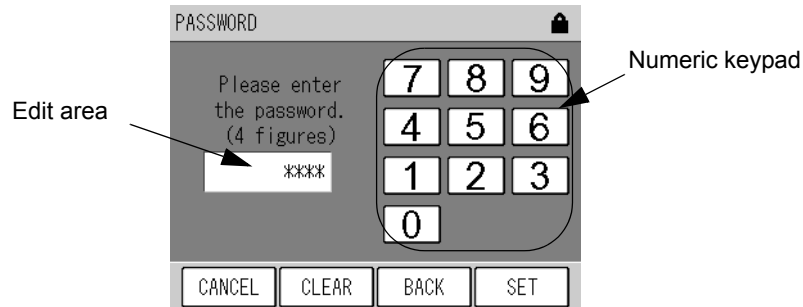

Fig. 83 PASSWORD screen

Enter a value via the numeric keypad.

The keys allow you to perform the following operations.

[CANCEL]: Cancels the password entry and returns to the KEY LOCK screen.

[CLEAR]: Deletes the value entered in the edit area

[BACK]: Deletes the just entered figure (1-digit).

[SET]: Enters the value in the edit area as a password.

2. Enter the 4-character password and then press the [SET] key.

If the entered password is correct, the requested action will occur.

If not correct, no action will occur and the PASSWORD screen will be displayed again.

Tip

The default password is 1234.

7 DAILY CHECKS

7.1 Before Maintenance

Prior to maintenance, perform the following steps to turn ON the maintenance switch. When the maintenance switch is ON, the MNT signal is outputted via the signal connection terminal block.

— Tip —

For the terminal block output, see the rear panel signal table at the end of this document.

1. Press the [MAINT.] key on the MEAS. screen. The MAINTENANCE screen will be displayed.

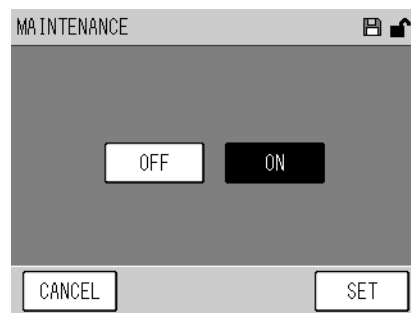

Fig. 84 MAINTENANCE screen

The current status of the maintenance switch is highlighted.

- [ON]: Highlighted when the maintenance switch is ON.
- [OFF]: Highlighted when the maintenance switch is OFF.

If the external switching is not selected, the status of the maintenance switch can be changed by pressing the [ON] or [OFF] button.

- [ON]: Turns ON the maintenance switch.
- [OFF]: Turns OFF the maintenance switch.

The keys allow you to perform the following operations.

- [CANCEL]: Cancels the operation and returns to the MENU/SYSTEM screen.
- [SET]: Performs the operation and returns to the MENU/SYSTEM screen.

2. Press the [ON] button.
3. Press the [SET] key.

7.2 Replacing the Filter Element

The filter element is used to purify the sample gas and protect the analyzer.
If the filter element is used over a long period, the flow rate of the sample decreases.

Recommended frequency of maintenance

- Filter element:
About every 2 weeks (depending upon the sample conditions)

Reference

- See the instruction manual of CU-2.
- See the maintenance manual of APNA-370.

7.3 List of Consumables and Replacement Parts

No.	Name	Specification	Qty.	Part No.	Replacement period
1	Diaphragm assembly	EPDM for GS and GD series	2	9022002900	1 year
2	DO unit	For deozoneizer	1	9022010000	1 year
3	UV lamp unit	(ozonizer unit)	1	9022009500	1 year
4	UV liner	263 × 145 × 0.8 (t) mm, PTFE	1	9057004300	1 year
5	Dehumidifier unit	For APNA-370	2	9022009900	1 year
6	Catalyst tube	For NOx converter	1	9020001000	1 year
7	Air filter	0.3 μm	1	9026000200	1 year
8	Scrubber	BAA-050 (activated alumina)	1	9022006400	1 year
9	Silica gel	Containing 500 g	1	9057003600	1 year
10	Pump unit	GD-6EH-100	1	9022005500	2 years
11		GD-6EH-230	1	9022005600	2 years
12	Solenoid valve	WTA-2K-MFF-1	3	9022009600	2 years
13	LCD unit	For APXX	1	G0256120	3 years
	Battery	CR2032	1	9022009800	3 years

Note

- The above replacement period is given as recommended and does not assure any performance. The replacement period of consumables may become shorter depending upon the installation environment and operating conditions.
- In order to maintain the accuracy, it is recommended that periodical maintenance and checks be performed when consumables are replaced. For information on maintenance and checks, etc., contact us.

8 TROUBLESHOOTING

8.1 Alarm Check

- **Alarm indicator**

When an error occurs in the analyzer, the [ALARM] key will be displayed on the lower right of the MEAS. screen. In addition, the Power ON LED will change from green to red.

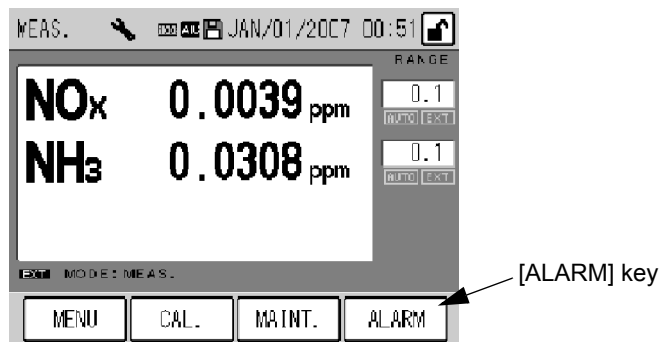

Fig. 85 Alarm indicator

- **ALARM screen: Checking the current alarm status**

This screen allows you to check the current alarm.

When an alarm occurs, the [ALARM] key will be displayed. Pressing this key displays the ALARM screen.

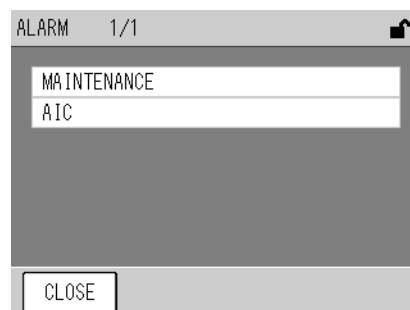

Fig. 86 ALARM screen

The currently occurring alarms are listed. One page can contain up to 6 alarm items.

A maximum of six alarms can be displayed on each page. If 7 alarms or more occurs, all the alarms can be viewed by turning pages with the function keys.

The keys allow you to perform the following operations.

- [CLOSE]: Returns to the MEAS. screen.
- [◀]: Displays the previous page.
- [▶]: Displays the next page.

● **Alarm icon: Checking the data alarm status**

The screen for data check displays an alarm icon to show that data has been acquired during the occurrence of an alarm.

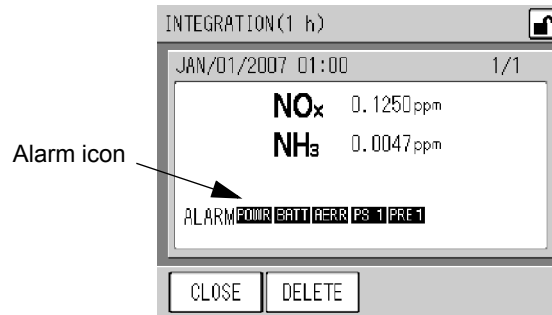

Fig. 87 Alarm icon

Alarms identified by the alarm icon displayed on the screen for data check are given below. For the possible cause and remedial action for each alarm, see the description in "8.2 Alarm List" (page 71).

Table 2 Alarms identified by alarm icons

Alarm icon	Alarms	Reference	Remarks
ZERO	Zero calibration	page 71	
SPAN	Span calibration	page 71	
FLO1	Flow rate 1	page 71	optional
PRE1	Pressure 1	page 72	
CONV	Converter temperature	page 72	
TELE	Telemeter failure	page 72	
CAL	Calibration	page 72	Hidden on the ALARM screen
LINE	Line	page 72	
AIC	AIC	page 72	
POWR	Power ON	page 73	Hidden on the ALARM screen
BATT	Battery	page 73	
PS_1	Pressure sensor 1 error	page 73	
PS_3	Pressure sensor 3 error	page 73	
TS_1	Temperature sensor 1 error	page 73	
MNT	Maintenance	page 73	
I2C0	I ² C communication error ID0	page 73	

8.2 Alarm List

● ZERO: Zero calibration

The zero calibration is unsuccessful.

The zero calibration deviates from the specified range (± 3500 counts).

Possible cause	Remedial action	Reference
The measured value is not stable.	Perform the zero calibration again.	page 28
Any gas other than the zero gas has been supplied during the zero calibration.	Supply the zero gas.	---

● SPAN: Span calibration

The span calibration is unsuccessful.

The span calibration deviates from the specified range (0.5 to 2.0).

Possible cause	Remedial action	Reference
The measured value is not stable.	Perform the span calibration again.	page 29
The Span gas concentration is wrong.	Check the span gas concentration and perform the span calibration with gas of the proper concentration.	---
The Span gas concentration is set improperly.	Set the span gas concentration properly.	page 15

● FLO1: Flow rate 1 (optional)

Flow rate deviates from the specified range.

Sample flow rate deviates from the specified range (0.8 L/min to 1.4 L/min).

— Tip —

Flow rate can be checked on the ANALOG INPUT screen (Fig. 58 on page 48).

Possible cause	Remedial action	Reference
There is a leak on the measured gas line or the calibration gas line.	Check to see whether the measured gas line and the calibration gas line are connected properly. If either or both of these gas lines are disconnected, connect them properly. If your remedial action is unsuccessful, contact us.	page 3

● PRE1: Pressure 1

Detector pressure deviates from the specified range.

Possible cause	Remedial action	Reference
The piping has a leak or is disconnected.	Check to see whether the piping is connected properly. If the piping is disconnected, connect it properly. If your remedial action is unsuccessful, contact us.	page 3
The filter is contaminated.	Replace the sample filter element.	page 68
The pump has deteriorated.	If more than 2 years have passed since the replacement of the previous pump, replace the pump. Otherwise, contact us.	---

Note

For replacing parts, contact us.

● CONV: Converter temperature

NOx converter temperature is too low.

Possible cause	Remedial action	Reference
The instrument has not warmed up sufficiently.	Warm up the instrument.	page 4
The ambient temperature deviates from the specified range (5°C to 40°C).	Allow the instrument to stand for a while in an environment of temperature within the specified ambient temperature range.	---

● TELE: Telemeter failure

A telemeter error has occurred.

The telemeter input is OPEN only if a telemeter is connected.

Possible cause	Remedial action	Reference
No closed contact signal is received from the telemeter.	<ul style="list-style-type: none"> ● Check the telemeter. ● Check the wiring. 	---

● CAL: Calibration

Calibration is executed.

This shows an operating status. No remedial action is required.

● LINE: Line

The measurement line is set to other than MEAS.

Otherwise, it is in the middle of the WAIT time for MEAS., which is specified in the AIC sequence, after line switching from ZERO or SPAN to MEAS.

This shows an operating status. No remedial action is required.

● AIC: AIC

The automatic calibration sequence is in progress.

This shows an operating status. No remedial action is required.

● **POWR: Power ON**

The power is turned ON.

This shows an operating status. No remedial action is required.

● **BATT: Battery**

The voltage of the battery for memory backup has decreased.

Possible cause	Remedial action	Reference
The battery reaches the end of its service life (about 3 years).	Replace the battery. If the settings return to the default value after the battery has been replaced, set the current time and AIC start time again.	---

Note

For replacing parts, contact us.

● **PS_1: Pressure sensor 1 error**

The detector pressure sensor or sensor circuit fails.

Possible cause	Remedial action	Reference
Sensor failure or circuit board failure	Contact us.	---

● **PS_3: Pressure sensor 3 error**

The atmospheric pressure sensor or sensor circuit fails.

Possible cause	Remedial action	Reference
Sensor failure or circuit board failure	Contact us.	---

● **TS_1: Temperature sensor 1 error**

The detector temperature sensor or sensor circuit fails.

Possible cause	Remedial action	Reference
Sensor failure or circuit board failure	Contact us.	---

● **MNT: Maintenance**

The maintenance switch is turned ON via the MAINTENANCE screen. Otherwise, the maintenance contact is turned ON with an external signal.

This shows an operating status. No remedial action is required.

● **I2C0: I²C communication error ID0**

This is an internal error.

Contact us.

8.3 Troubleshooting

This section describes troubleshooting mainly for the part replacement and checks, which are expected to be performed by the customer.

If your trouble is not rectified through these efforts, be sure to contact us.

Note

Prior to taking your action, check the following points again:

- The power source is connected.
- The power supply voltage and capacity conform to the specifications.
- The replacement of parts is performed as specified.

● No output signal is available.

Possible cause	Remedial action	Reference
No gas is supplied.	Check the measured gas line and calibration gas line for disconnected piping.	page 3
	Check to see whether the pump is operating.	---
No ozone is generated.	Turn ON the ozonizer .	---

● The output signal level is too low.

Possible cause	Remedial action	Reference
The range not set improperly.	Set the range properly or select the automatic range.	page 50
The zero calibration is not accurate enough.	Perform the calibration again.	page 28
The span calibration is not accurate enough.	Perform the calibration again.	page 29
The silica gel has deteriorated.	Replace the silica gel.	---
The performance of the DO unit has deteriorated.	Replace the catalyst.	---
The temperature of the detector block heater case is too low.	When the detector block heater case is normal, its temperature is adjusted to approximately 45°C. Check the temperature wearing thin cotton work gloves.	---
The ozone generation performance has deteriorated.	Check the UV lamp for the time of its replacement (1 year). If it has been used for more than 1 year, replace it.	---
The sample inlet or outlet has pressure loss.	Check the piping for clogging near the sample inlet or outlet. Rectify the piping for the sample inlet and outlet.	---
The filter is contaminated.	Replace the filter. Replacement period of the filter element: Every 2 weeks	page 68

Note

For replacing parts, contact us.

● **The output signal level is too high.**

Possible cause	Remedial action	Reference
The range not set improperly.	Set the range properly or select the automatic range.	page 50
The zero calibration is not accurate enough.	Perform the calibration again.	page 28
The span calibration is not accurate enough.	Perform the calibration again.	page 29

● **The readings are not stable enough.**

Possible cause	Remedial action	Reference
The flow rate is unstable.	Check the filter. If the filter is found contaminated, replace it. Replacement period of the filter element: Every 2 weeks Replacement period of the air filter: Every year	page 68
	Check the pump and diaphragm. If they have been used exceeding their replacement time, replace them. Replacement period of the diaphragm: Every year Replacement period of the pump unit: Every 2 years	---

Note

For replacing parts, contact us.

● **The noise level is too high.**

Possible cause	Remedial action	Reference
Condensation occurs throughout the instrument.	Allow the instrument to stand for a while in an environment of stable temperature within the operating temperature range until condensation disappears.	---
The silica gel has deteriorated.	Replace the silica gel.	---
The performance of the DO unit has deteriorated.	Replace the catalyst.	---
The temperature of the detector block heater case is too low.	When the detector block heater case is normal, its temperature is adjusted to approximately 45°C. Check the temperature wearing thin cotton work gloves.	---
The ozone generation performance has deteriorated.	Check the UV lamp for the time of its replacement (1 year). If it has been used for more than 1 year, replace it.	---

Note

For replacing parts, contact us.

9 EXTERNAL INPUT/OUTPUT

The details of input/output depends upon the specifications.
 This chapter describes the case that a standard circuit board, AP-RPL-02, is mounted.

9.1 Terminal Block Specifications

For the details of the terminal block specifications, see the rear panel signal table.
 All outputs and all inputs are provided at contact points except for analog outputs.
 The ON/OFF status is input/output as follows:



Fig. 88 ON/OFF status of a contact terminal

The functions of the terminals are described below:

9.1.1 Range output for analog output

The current momentary value range is output as follows:

Output				Range
Range 1	Range 2	Range 3	Range 4	
ON	OFF	OFF	OFF	Range 1 (minimum concentration)
OFF	ON	OFF	OFF	Range 2
OFF	OFF	ON	OFF	Range 3
OFF	OFF	OFF	ON	Range 4 (maximum concentration)

9.1.2 Contact input

Note

- The inputs of the AIC start and integration reset do not respond to the changes occurring within less than 0.1second.
- The input of telemeter failure does not respond to the changes occurring within less than 0.5 second.

The executed operations depends upon the input status:

AIC start

When the AIC MODE is set to [EXTERNAL], changing this input from OFF to ON causes the following operation:

Instrument status	Operation
No AIC sequence is in progress.	Starts an AIC sequence
An AIC sequence is in progress.	Nothing

9.1.3 Contact output

AIC

This output is ON when the AIC sequence is in progress.

Maintenance

This output is ON during the maintenance mode.

9.1.4 Alarm output

This output shows that an alarm as described below is occurring.

Calibration error

This output is turned ON when the zero calibration error or span calibration error occurs.

General error

This output is turned ON when any alarm other than the AIC, MNT, ZERO, SPAN or Calibration error occurs.

The details of general error output vary depending upon the specifications. See the list of general errors at the end of this document.

For information on each alarm, see “Table 2 Alarms identified by alarm icons” (page 70) and “8.2 Alarm List” (page 71).

9.1.5 Analog output

Tip

The analog output data can be set to any of the measurement value, AVERAGE 1, AVERAGE 2, AVERAGE 3, INTEGRATION, or ROLLING AVERAGE, as well as the standard setting.

These outputs are provided regardless of the MODE setting on the MEAS. screen.

9.1.6 Power shutoff output

Power shutoff

This output is ON when the power is OFF.

10 APPENDIX

10.1 Measurement Principle

If nitrogen monoxide (NO)/dioxide (NO₂) in the sample gas reacts with ozone (O₃), part of the NO is oxidized to become nitrogen dioxide (NO₂).

Part of the NO₂ generated is in the excited state (NO₂^{*}) and radiates light when it changes to the ground state. This phenomenon is called chemiluminescence.

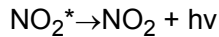
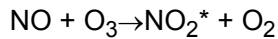

This reaction is extremely fast and only NO is involved - without almost any no effect on the other coexistent gases. If the NO is at a low concentration, the quantity of luminescence is in proportion to that concentration. Measuring the NO concentration with this reaction is known as the chemiluminescence method (CLD method).

NH₃ in the sample gas is oxidized to NO at CU-2 in this NH₃ measurement device, and then the NO is measured by APNA-370.

A sample gas is divided into two portions at CU-2. One portion is to pass through only NOx converter which reduces NOx to NO (NOx line), and the other portion is to pass through an oxidized catalyst which changes NH₃ into NO and NOx converter (NOx + NH₃ line).

APNA-370 measures NO in these two lines and calculates NH₃ concentration from the difference of NO measurement values.

10.2 Dryer Unit

This instrument incorporates self-reproducing-type silica gel dryer unit to dry the air used to form ozone.

The dryer unit has two drying cylinders. When one drying cylinder is in use, the other is being reactivated. In reactivation, the silica gel is heated at about 160°C for 135 minutes to expel the moisture, and then cooled for 45 minutes.

Continuous drying is achieved by using and reactivating the two lines interchangeably every 180 minutes.

10.3 Specification

Model:	APNA-370
Principle:	Cross-flow-modulation type semi-pressure-reduced chemiluminescence method
Ranges:	Standard: 1.0 ppm (0.1/0.2/0.5 ppm : reference range) auto-switching, remote switching possible
Repeatability:	Within $\pm 2.0\%$ of full scale
Zero drift:	$\pm 2.0\%$ of full scale value per day
Span drift:	$\pm 2.0\%$ of full scale value per day
Response time T_{90} :	Within 300 s
Input/output:	0 V to 1 V momentary value, integration value, or average Includes contact-point input/output, range, mode, external reset, telemeter fault, and ALARM. RS-232C (optional)
Sampling flow rate:	Approx. 2.0 L/min
Working temperature range:	5°C to 40°C
Working humidity range:	Maximum relative humidity 80% for temperature up to 31°C decreasing linearly to 50% at 40°C
Power source:	100, 110, 115, 120, 220, 230, 240 V AC (as specified) 50 Hz/60 Hz
Power consumption:	200 VA for normal operation
External dimensions:	430 (W) \times 221 (H) \times 550 (D) mm (excluding front and rear extrusions)
Mass:	Approx. 21 kg

10.4 Unpacking

Unpack the package and check that the following items are included:

Checklist for items included	Check box
● Main unit 1 set	<input type="checkbox"/>
● Instructional materials 1 set	
Instruction manual: 1 copy	<input type="checkbox"/>
Communication (RS) guide (optional): 1 copy	<input type="checkbox"/>
● Standard accessories: 1 set	
Power cable set: 1 piece	<input type="checkbox"/>
Filter elements (PA-10L, 24 pieces): 1 box	<input type="checkbox"/>

10.5 Installation

Note

To transfer the instrument, support its bottom by at least 2 persons.

10.5.1 Installation environment

The APNA-370 has been designed for uses under general ambient conditions without assuming any use under special conditions. Install the APNA-370 in a location where the following conditions are met.

- Transient overvoltage of main power source:
Overvoltage category II (IEC60364-4-443), Pollution level 2
- Fluctuation of power supply voltage: Reference voltage $\pm 10\%$
- Power supply frequency: Reference frequency $\pm 1\%$
- The ambient temperature shall be between 5°C and 40°C without any rapid change of 5°C or more.
- The location shall not be exposed to direct sunlight, hot air from a heater, and draft from an air-conditioner.
- The location shall be level.
- It shall be free from significant vibrations and any powerful electric or magnetic field.
- The dust level shall be 0.1 mg/m^3 or less.
- There shall be no corrosive gas.
- The relative humidity shall be 85% or lower.
- The altitude shall be 3,000 m and under.
- A 3-pole power cable set shall be applicable.

10.5.2 Installation place

- 19-inch standard rack
- Cut panel
- Flat desktop

As illustrated, this instrument requires 222 mm for its vertical space when installed on a 19-inch rack or cut panel.

It also requires 4 mounting screws and a supporting base.

For the mounting plate and sliding rails, use the optionally available ones.

To install the instrument on a desktop, remove its securing plates located on both sides, which are used for installation on a rack or cut panel.

For a rack or panel, use a supporting base for the bottom of the APNA-370.

Service space

Allow sufficient service space in front of, and behind the instrument.

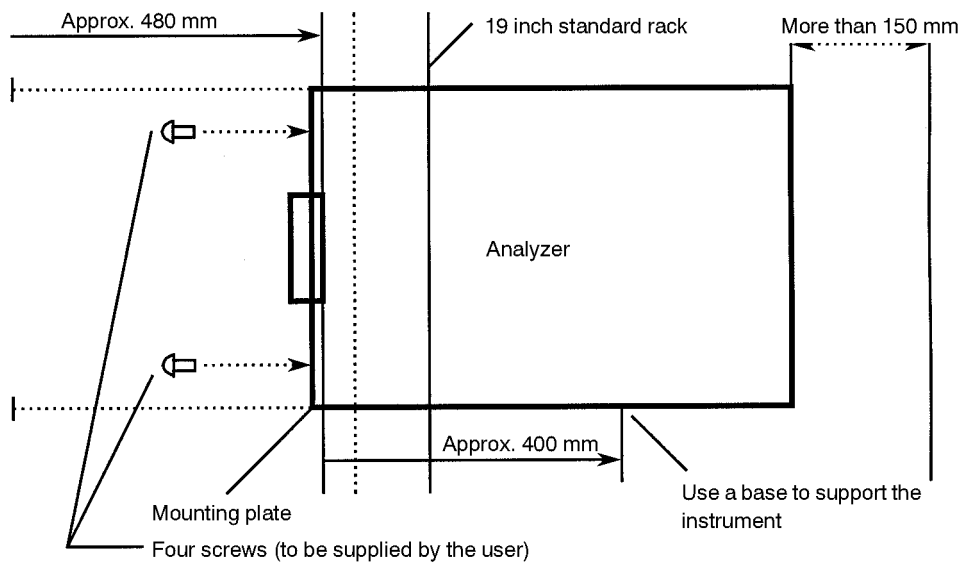

Fig. 89 Mounting the APNA-370 on a 19-inch rack

The following figure shows a cut panel and its screw positions.

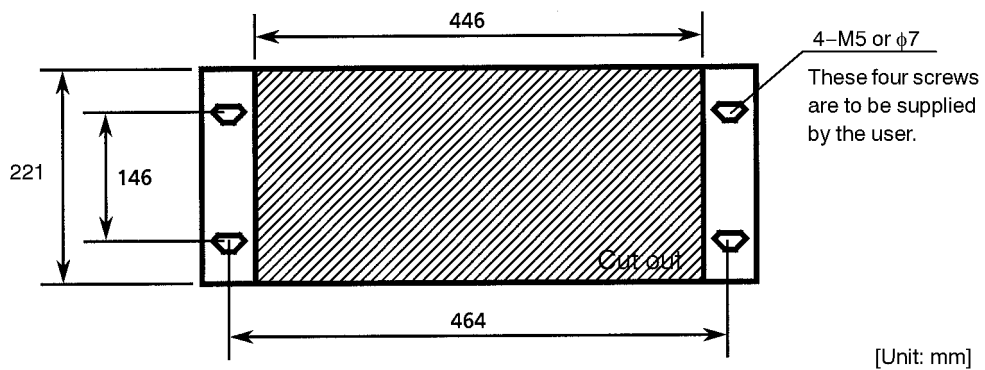

Fig. 90 Mounting the APNA-370 on a panel

As illustrated, place a supporting base behind the instrument.

Note

The mounting plate and sliding rails are available optionally.

HORIBA, Ltd.

2 Miyanohigashi, Kisshoin Minami-ku, Kyoto 601-8510 Japan
<http://www.horiba.com>
